

Nähmaschinen-Ersatzteile

Sewingmachine Spare parts

Piezas de recambio para máquinas de coser

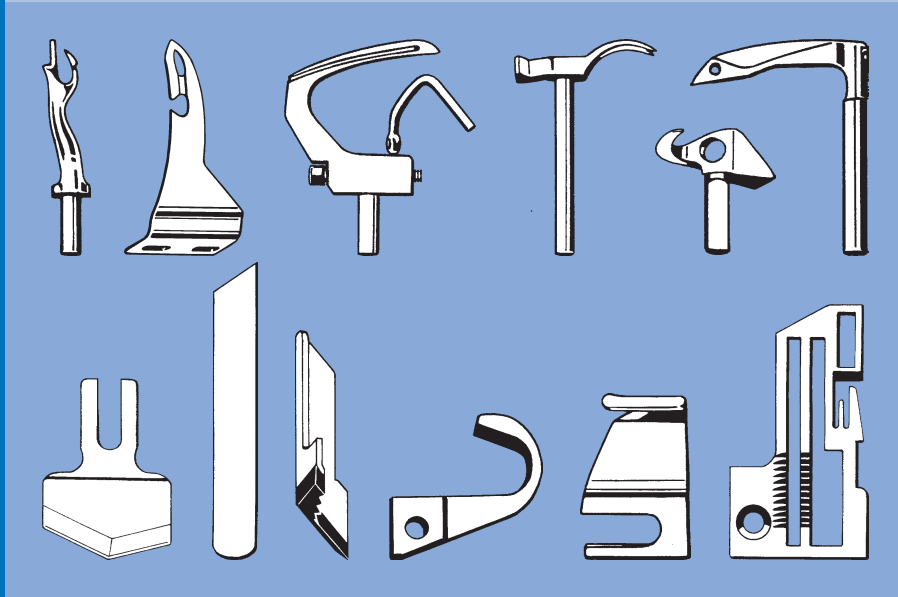
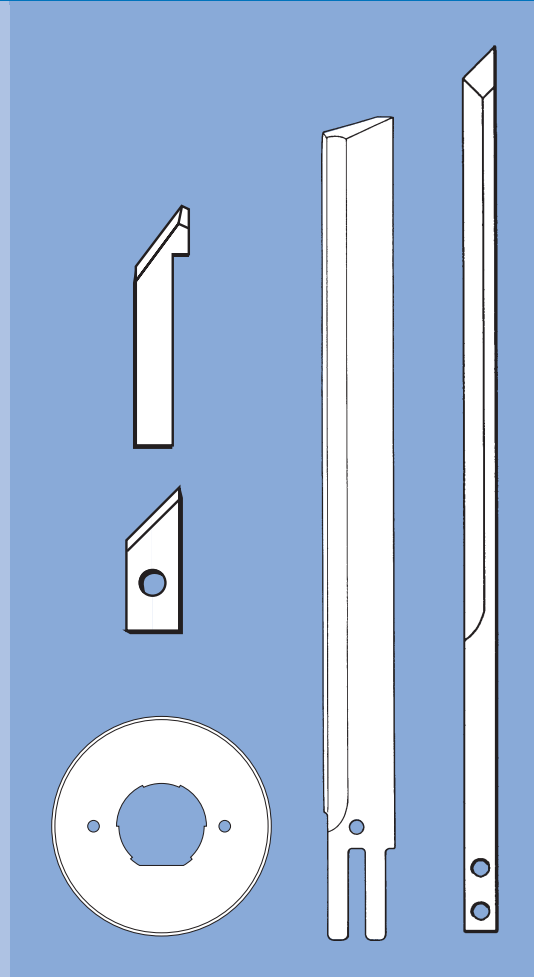

**2022**

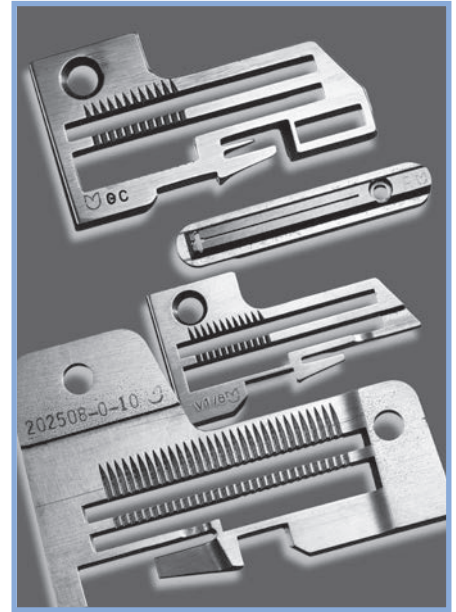
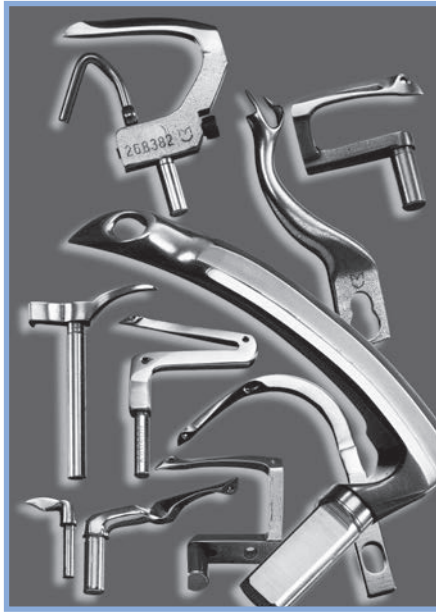

 **MAIER**-Ersatzteile sind  
Qualitätsprodukte.

Die in diesem Katalog aufgeführten Teile führen wir regelmäßig auf Lager. Sie sind nicht vom Hersteller der Original-Maschinen gefertigt, entsprechen jedoch genau den betreffenden Originalen.

Sonderteile fertigen wir nach Ihrem Muster oder Ihrer Zeichnung in jeder gewünschten Stückzahl.

Wir erwarten gerne Ihre Anfrage.

 **MAIER**-spare parts are  
quality products.

The parts listed in this catalogue are regularly on stock. They are not produced by the manufacturer of the genuine machines but correspond exactly to the genuine parts concerned.

We produce special parts according to your sample or your drawing of any desired quantity.

We are looking forward to your inquiry.

 **MAIER**-Piezas de recambio  
son productos de  
alta calidad.

Almacenamos con regularidad las piezas mencionadas en este catálogo. No son productos del fabricante de las máquinas originales, equivalen, sin embargo, exactamente a las correspondientes piezas originales.

Toda cantidad de piezas especiales se fabrican según sus muestras o dibujos.

Aguardamos su grata demanda.

## DAMIT SCHNEIDEN SIE GUT AB:

- Maschinenmesser
- Präzisionsteile
- Baugruppen

Sie bekommen genau die Präzision die Sie brauchen, denn Sonderanfertigungen stellen wir exakt nach Ihren konstruktiven Vorgaben her. Ob Industrienäh-, Strick- und Textilmaschinen, Schneidplotter oder Maschinen für Kabelabsolierung, Holzbearbeitung, Kunststoffrecycling, Lebensmittelherstellung etc. Ihre Anforderungen, Wünsche und Vorstellungen sind für uns das präzise Maß der Dinge.

## HOW TO OBTAIN CUTTING:

- machine knives
- precision parts
- components

You get the precision you need because we make special products exactly to your structural design requirements. Industrial sewing machines, knitting and textile machinery, cutting plotters or insulation cable machines, wood working, plastics recycling, food manufacture and so on. Your requirements, wishes, and ideas are, for us, the measure of what we do.

## CORTE EXCELENTE:

- cuchillas de máquina
- piezas de precisión
- grupos constructivos

Le proporcionamos toda la precisión que necesita, pues realizamos artículos especiales exactamente según sus especificaciones constructivas. Sus indicaciones, deseos ideas representan para nosotros la medida de todas las cosas, ya sea para máquinas de coser industriales, de géneros de punto o artículos para vestir, plotter de corteo máquinas para el aislamiento de cables, mecanizado de madera, reciclado de material sintético o la producción de alimentos.

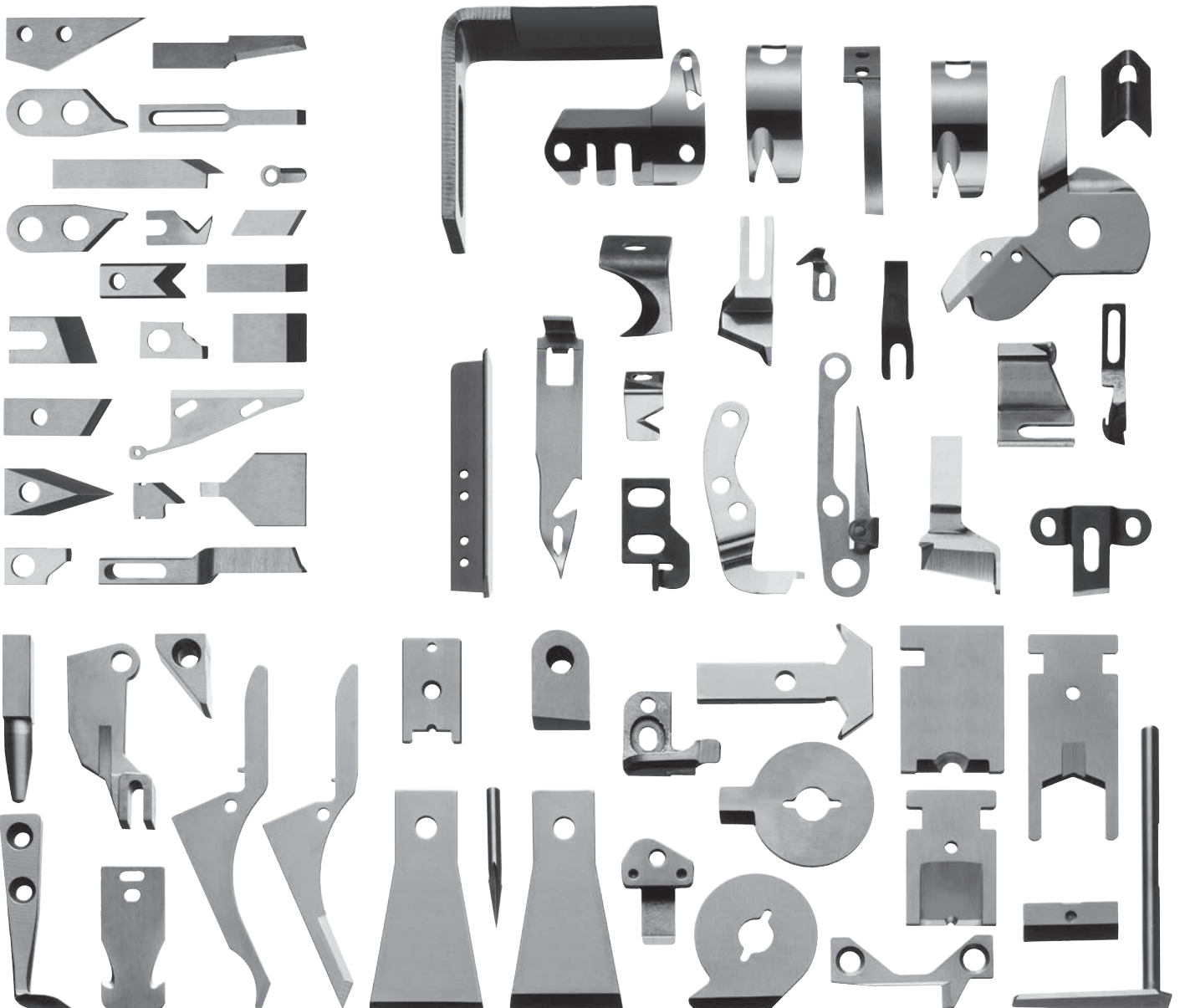



8516



81077009 (CT)



81071606



81071614

Weitere Messer und Greifer für  
Textima/Altin auf Anfrage.

Further knives and looper for  
Textima/Altin on request.

Otras cuchillas y anclas para  
Textima/Altin de ser demandadas.

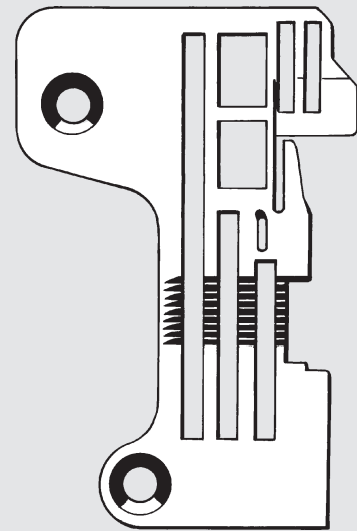

81073087

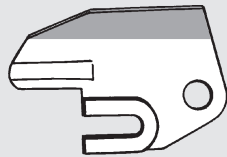

81074018 (CT)



81071415



81071401

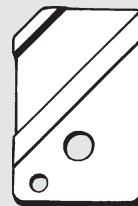

81071609

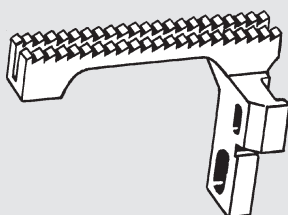

81073371

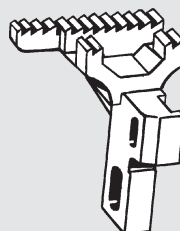

81073034



LK3-B 430, B 433, B 434, B 441  
BE 438C, BE 438D, BE 438 F  
KE-430C-436C, KE 430D, KE 430 F  
KE 438D, KE 484C, KM-4300

BAS 310, 311, 326, 341, 342  
BAS 430, 433  
BAS 300G, 311G, 326G, 342G

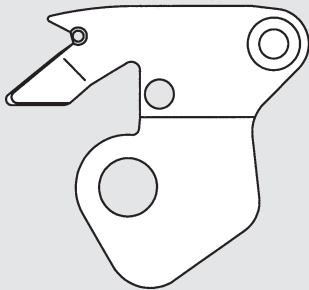

152901-001

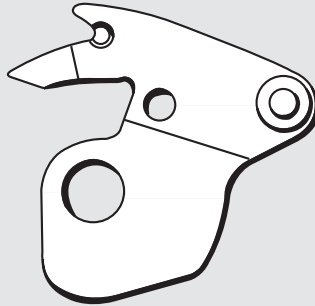

154176-001

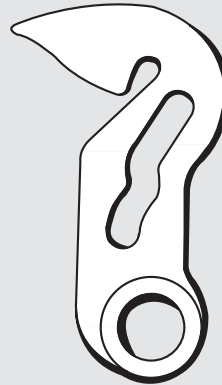

152906-001



S31612-001



S 49988-001

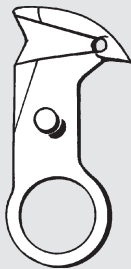

S 10205-001



SA 6596-001  
SA 3330-001



SB1189-001

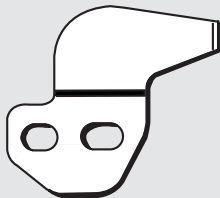

SA 3335-001

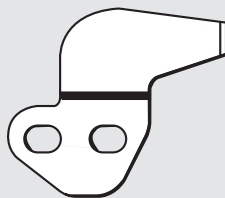

SA 6431-001

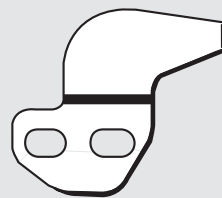

SA 7944-001

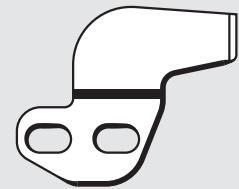

SB1191-001



S 10210-001  
S 10210-201



152905-001

**BAS 320, 322**

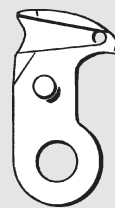

S 02375-001

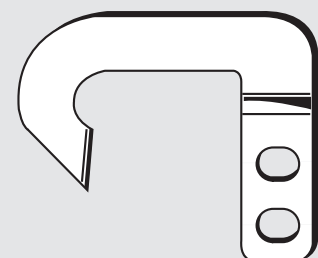

S 02374-001



**B 484**

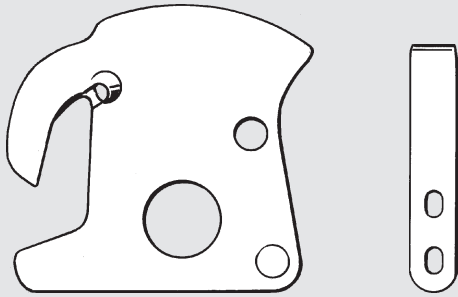

S 00706-201

S 00713-001

**DB2-B 716**

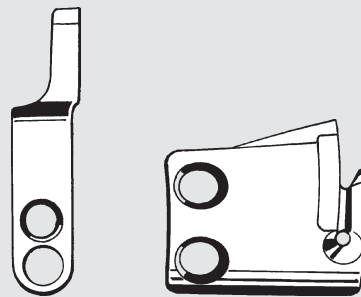

154568-001

154575-001

**BSC 7760**



S 44134-001

**B 711, B 737, B 738, B 791, B 798  
BAS 760**

**S 6200 A, S 7200 A, S 7200 B, S 7200 C, S 7300 A  
SL 737, SL 7200 A, SL 7200 B, SL 7220 B**



159540-001

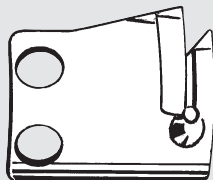

159915-001

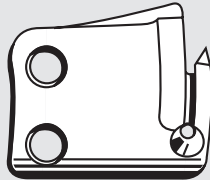

159799-001

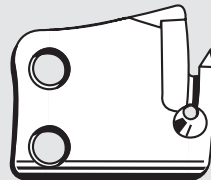

159541-001



SB4941-001

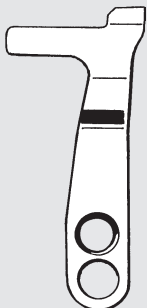

S 02637-001  
S 02637-101



S 45900-101

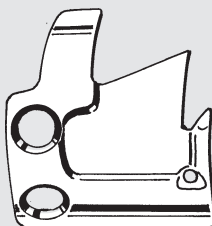

S 02645-001

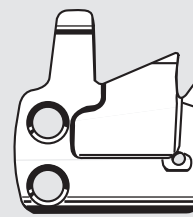

S 02646-001

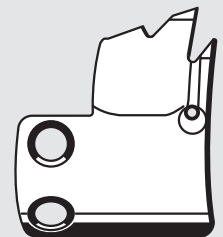

SB4942-101



**B 600, B 832, B 833, B 837  
BAS 620**



159365-001



153019-001



S 16248-101

**DBZ-B 755**

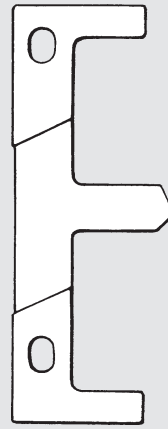

142061-001

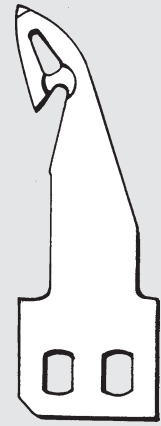

142058-001

**DB 2-B 772  
BAS 423  
SL 777 B**



S 32474-001

**SL 777 A, SL 778 A  
SN 771 A, SN 772 A**



S 10605-001



S 10605-201

**DT 6-B 924, B 928**



SY 0069084

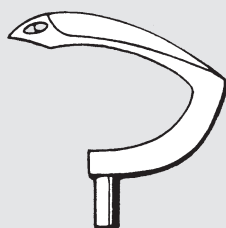

SY 0069085



SY 0069086

**B 931, B 932  
JC-9330, JC-9331  
JC-9380, JC-9381**



110121-001

**LS 5-P 73/P 81**



S 27634-001



**B 912, B 913, B 915, B 917**  
**BM-916 A, BM-917 A, BM-917 B, BM-917 C**



S 03536-001

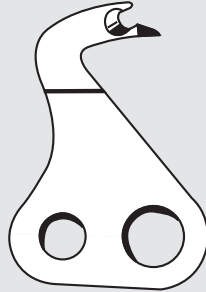

S 03627-001



S 03629-001

**B 926-6A**

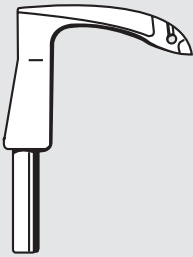

148869-001

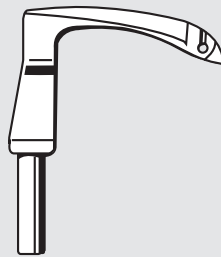

148870-001

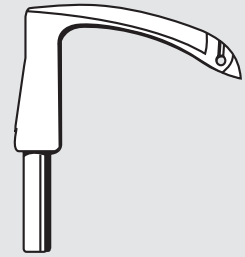

148871-001

**B 928**

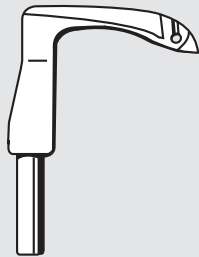

S 40375-001

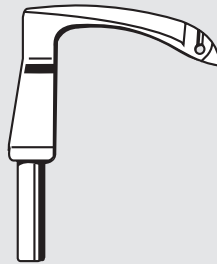

S 40376-001

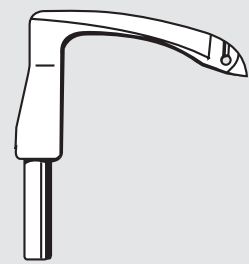

S 40377-001

**Homelock**

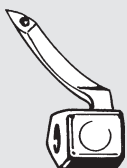

127814-001  
Kl. 127

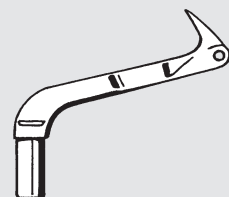

127260-001  
Kl. 522





LT 2-B 842, LT 2-B 875  
T-8422A, T-8452A, T-8722A, T-8752A  
TN-842B

T-8422B, T-8452B  
T-8722B, T-8752B

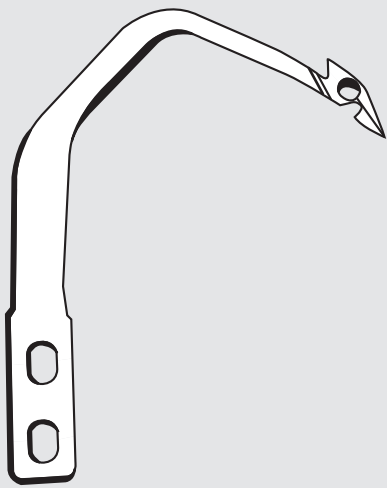

S 07526-001

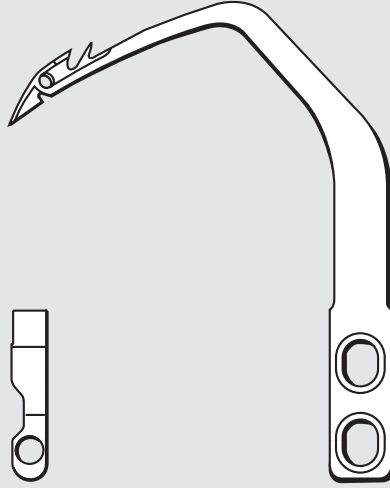

S 07527-001

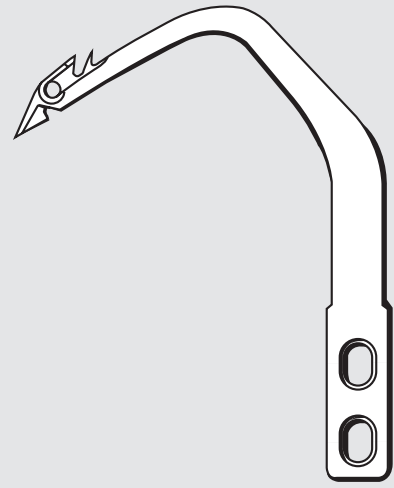

S 07526-201

S 07526-301

FD4-B 270 Series  
FD4-B 2700 Series

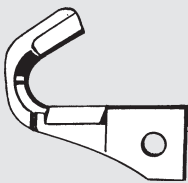

S 09094-001 (CT)

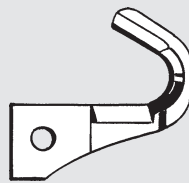

S 09093-001 (CT)

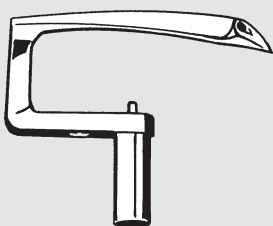

S 08913-001

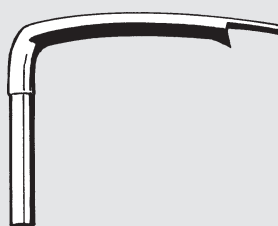

S 08934-001

B 281

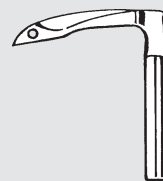

S 12842-001



S 12865-001



LH 4-B 812, B 814, B 815, B 816, B 860, B 800 E  
HE-8000, HM-8180, HE-800 A  
= Singer Kl. 71

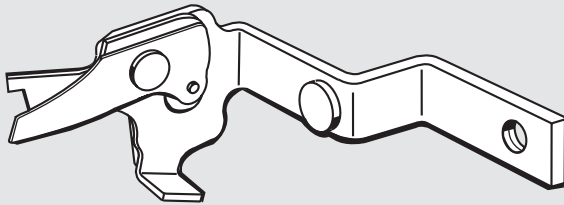

S 50404-401

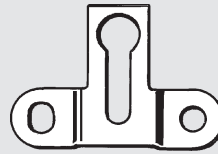

141543-001

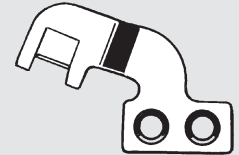

141541-001



S 50259-101



S 50260-101



S 50263-001

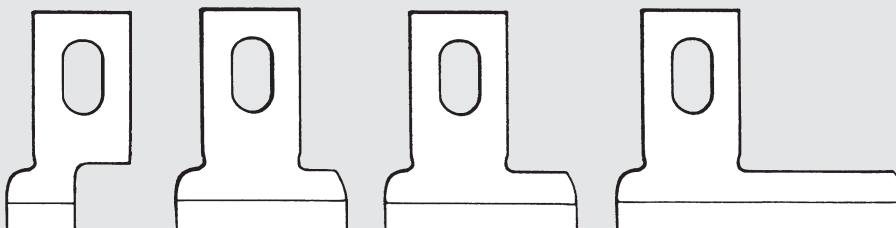
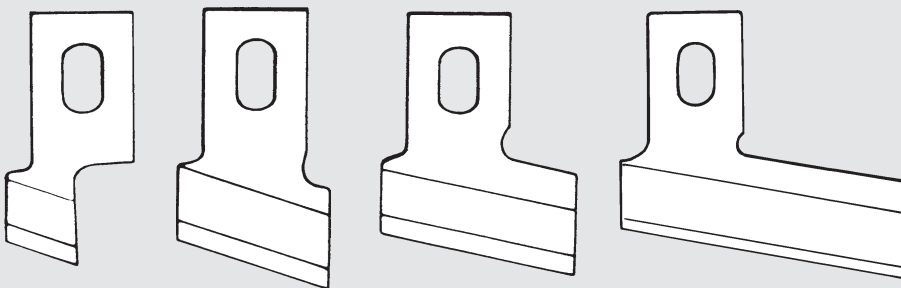

**HSS =**  
**High speed steel**  
**Acero rápido de alto**  
**rendimiento**

71 1/8	71 13/16
71 1/4	71 7/8
71 5/16	71 15/16
71 3/8	71 1
71 7/16	71 1 1/16
71 1/2	71 1 1/8
71 9/16	71 1 3/16
71 5/8	71 1 1/4
71 11/16	71 1 3/8
71 3/4	71 1 1/2

71-90 1/8	71-90 5/8
71-90 1/4	71-90 11/16
71-90 5/16	71-90 3/4
71-90 3/8	71-90 13/16
71-90 7/16	71-90 7/8
71-90 1/2	71-90 15/16
71-90 9/16	71-90 1



**DH 4-B 980**  
**RH 981 A, RH 982 A**  
**RH-9800, RH-9810, RH-9820**



S 35411-001



S 35410-001



S49078-001



SA 7634-101

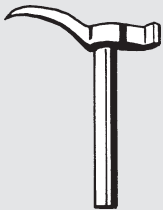

S 35412-101

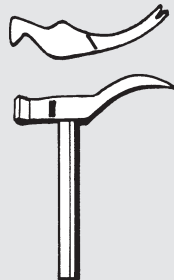

S 35413-101

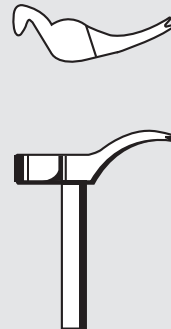

S 35472-101



S 34895-001



S 35029-001



S 37723-101



S 35033-001



S 35034-001



**DH 4-B 980**  
**RH 981 A, RH 982 A**  
**RH-9800, RH-9810, RH-9820**

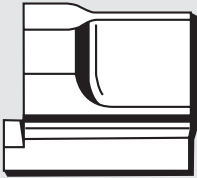

S 35092-001 20 mm  
S 35093-001 38 mm

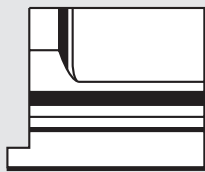

S 37195-001 22 mm



S 37706-001



S 37708-001



S 35437-101 (38 mm 2,8 x 4,3)

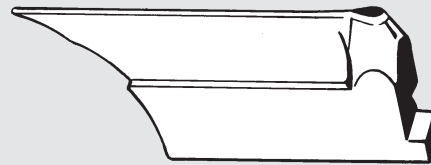

S 35480-101 (38 mm 3,0 x 4,6)

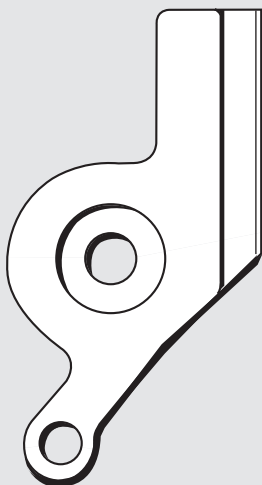

SA 6988-001

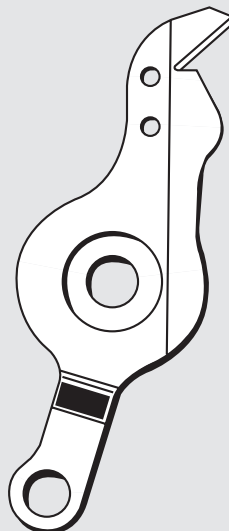

SA 6989-001



S 34899-001



**DA 9270, 9280**

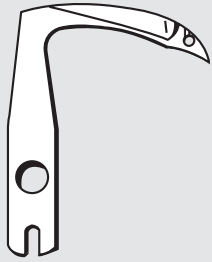

S 40389-001

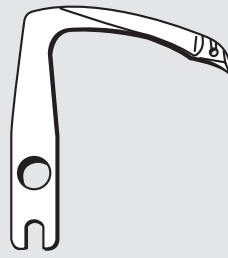

S 40390-001

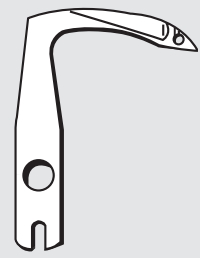

S 40391-001

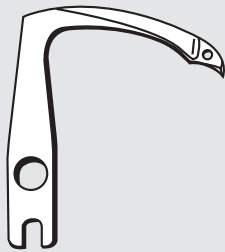

S 40392-001

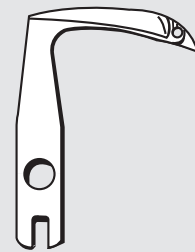

S 40393-001

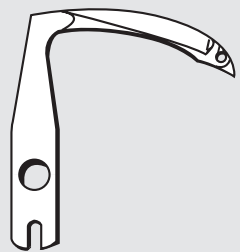

S 40394-001

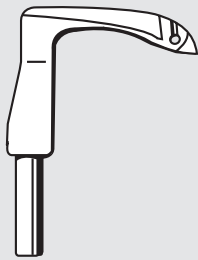

S 40375-001

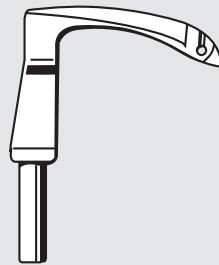

S 40376-001

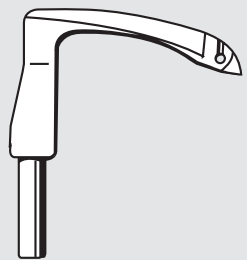

S 40377-001

**LS 52-B 891**



SSSS 60-292

**ZE-855 A, ZE-856A  
Z-8550 A, Z 8560 A**



S 55863-101



S 55864-001



**B 500 Series, B 600 Series, B 900 Series**



140567-001



CT 140567-001



140242-001 (CT)



148815-001 (CT)



148198-001

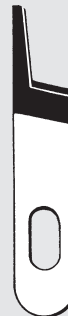

144074-001 (CT)

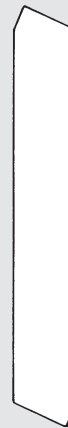

118527-001



144077-001



CT 144077-001

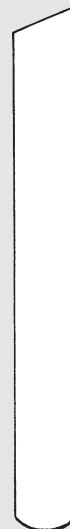

112436-001  
155193-001



CT 112436-001



**B 500 Series, B 600 Series, B 900 Series**

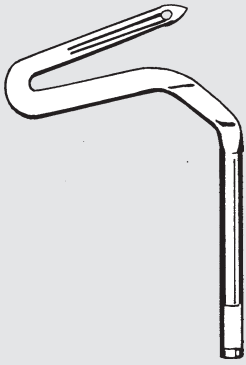

110736-001

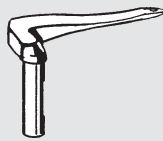

110737-001



147934-001  
146042-001  
146612-001

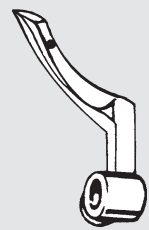

147936-001  
146792-001

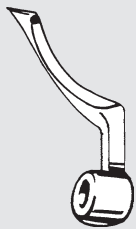

147937-001  
146962-001



144042-001



159686-001



155240-001



155241-001

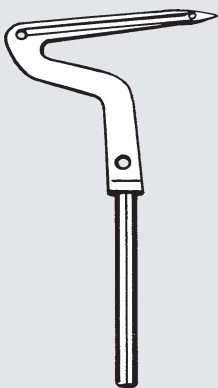

143734-001

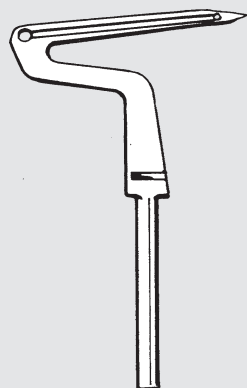

S 01248-001 (E)  
144049-001

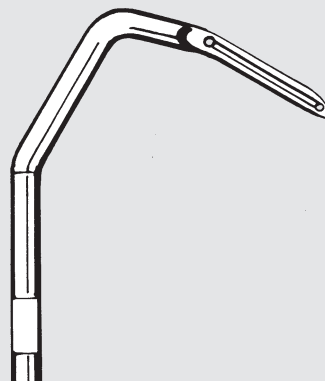

146635-001

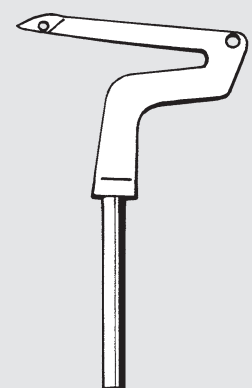

159434-001 (F)  
S 01249-001



**EF 4-V 41, -V 51, -V 71, -V 72, -V 81, -V 82  
MA 4-N 11, -N 21, -N 31, MA 4-V 61, -V 91, -V 92**



S 20896-001



S 20897-001



S 20579-001



S 20898-001



144074-001 (CT)



144074-300  
144074-200



S 20899-001



S 20582-001

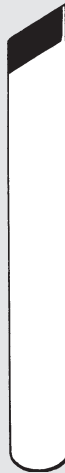

CT S 20582-001

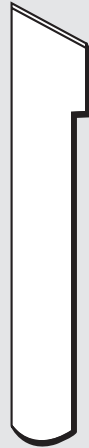

S 20583-001

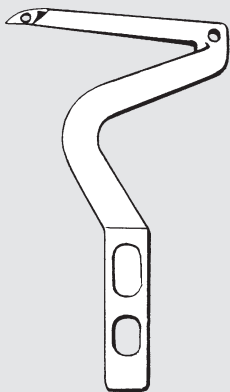

S 20626-001

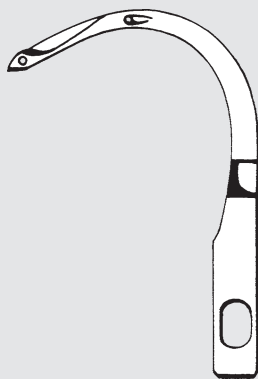

S 20653-001



S 20428-001  
V 41 (C)



S 20438-001  
V 41 (G)



S 20422-001  
V 41 (A)



S 20424-001  
V 41 (B)



S 20430-001  
V 41 (D)



S 20434-001  
V 51 (E)



S 20442-001  
V 61 (R)

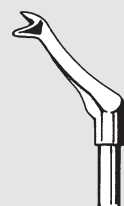

S 20421-001  
V 61 (L)





GP 1-71  
7000010071



GP 2-71  
7000020071



GP 3-4-71  
7000030071

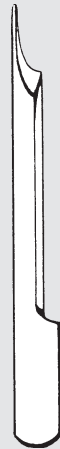

GP 5-71  
7000050071



GP 4-93  
7000040093



GP 7-71  
7000070071



GP 7-93  
7000070093



GP 8-71  
7000080071

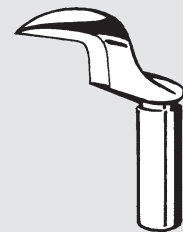

GP 8-93  
7000080093



77

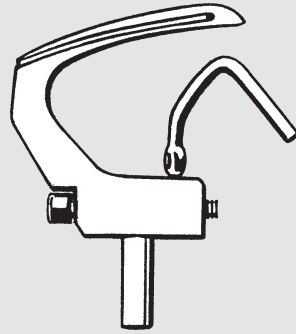

0077015050

68, 268, 368

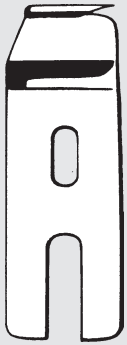

0068004600  
68460

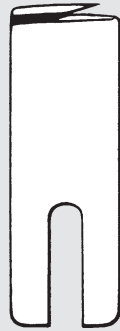

0268330470  
0068004620  
68462



68668-3,1



0268350030



0268350010

81



0081000820  
81082



0081000660  
81066



0083000820  
83082



0081005820  
81582 (CT)



0083000660  
83066



67, 167, 267, 367, 467, 477, 550, 667, 767, 768

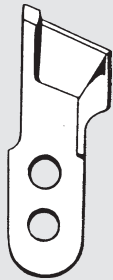

0367331330 (HSS)  
067330570



0367331310 (HSS)  
067330580



0367331320 (HSS)  
067330700



0367331300 (HSS)

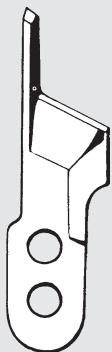

0067000460 (HSS)



0067351220



0167350010



0067351230



0067009360



0367330780 (HSS)



0167004610



0167004620



0167330020 (CT)



0367210240 (HSS)



CT 0367210240



0467200220



**67, 167, 267, 367, 467, 477  
550, 667, 767, 768**

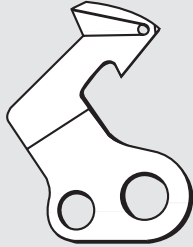

0367355030



0477330240

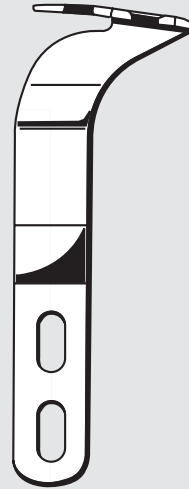

0767350280



0767350260

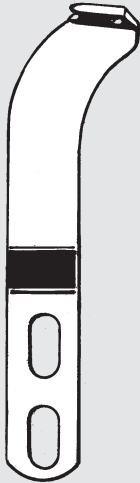

0367350070



0367350050



0467350330



0370221570

**171, 173, 175, 195, 197  
550  
742, 743, 744  
933, 939**

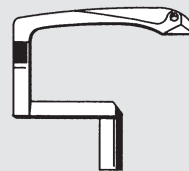

0933000337 A

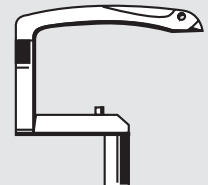

0195004753

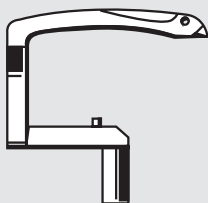

0195004753 A

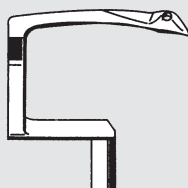

0195005055

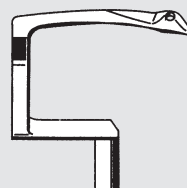

0195005055 A

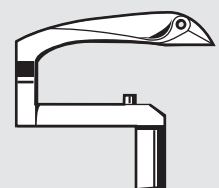

0171003253



**171, 173, 175, 195  
550  
742, 743, 744  
933, 939**



0196104017



0171004602



0933063983



0939017104



0933005712



0173003725

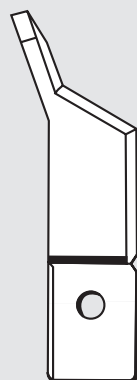

0195010127



0939017504

**211, 212, 219  
370, 380**

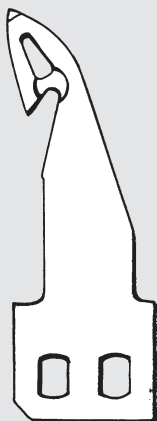

0219006708 A

**227, 237, 238, 249, 265  
697, 739-23**

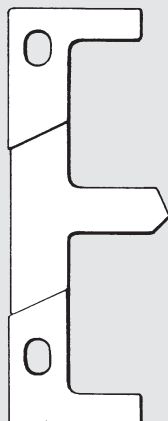

0211009685

**271, 272, 273, 274, 275**

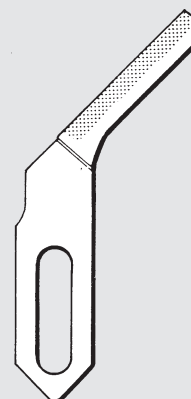

0212011368  
0212005058 (CT)



0204001065  
KI. 237-22 und 23



0227000683



0212004931 (CT)



0227000682



0697002075 (CT)



0219003963  
Solid carbide  
Metal solide duro



**211, 212, 219  
370, 380**

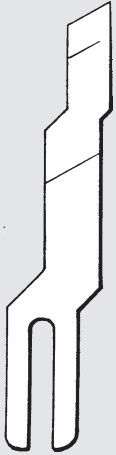

0238001418 (HSS)

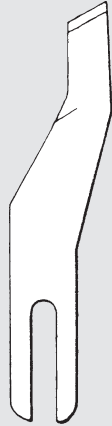

0238001417 (HSS)



0238016496

**271, 272, 273, 274, 275**

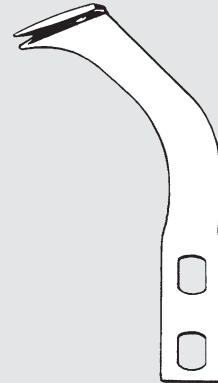

0380007293

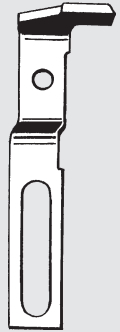

0238006549

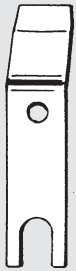

0271001497

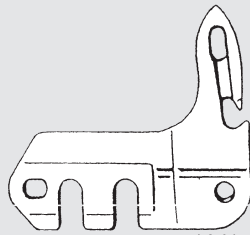

0271001483



0272076157

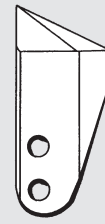

0272007042

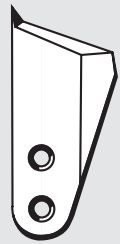

0272007045



0265008772



0211008504

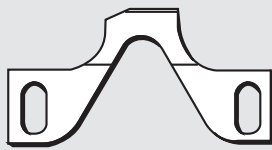

0265012265

**244, 245, 246, 247  
291, 292  
745**



0244014157



0291003002

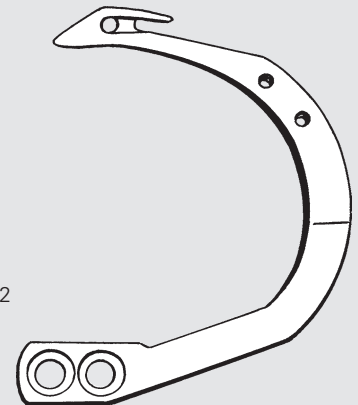

0291003004  
0244014161



**296**



0296200020



0296330430 (CT)

**396, 550**



0396350750



0396200090



0396330690



0396330700

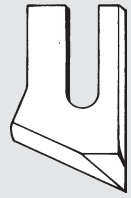

0396331600



0170200190

**251**

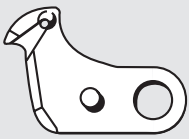

0251GR2438V2

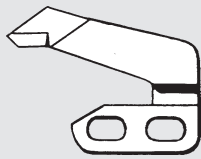

0251GR1705

**564, 566**

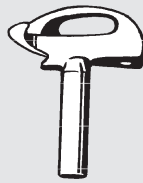

180614 DKP



0568330770



0568330760



0568350050

**570, 579**



0570000961

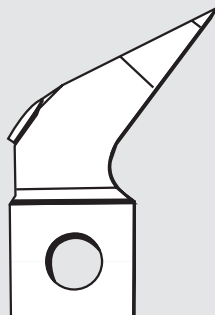

0570000962



0570092921

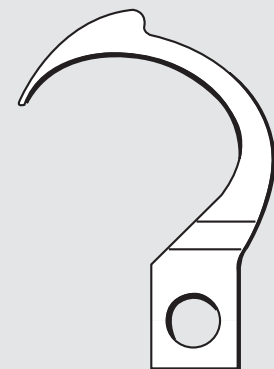

0570092925

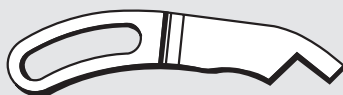

0570092917 A



0570092908 A



551, 555, 556, 576, 577, 540-100, 540-300

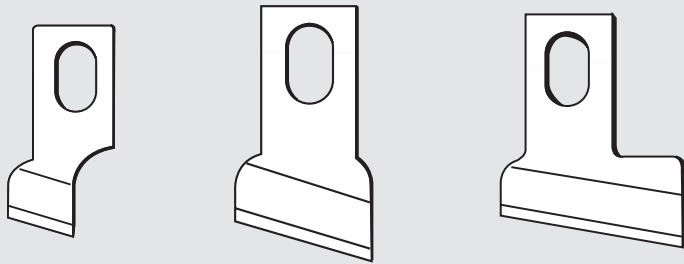

	mm		mm	Zoll
0576005701	6	0055000602	12,7	1/2
0576005702	8	0055000603	15,9	5/8
0576005703	10	0055000606	19,1	3/4
0576005704	12			
0576005705	14			
0576005706	16			
0576005707	18			
0576005708	20			
0576005709	22			
0576005710	24			
0576005711	26			
0576005712	28			
0576005713	30			

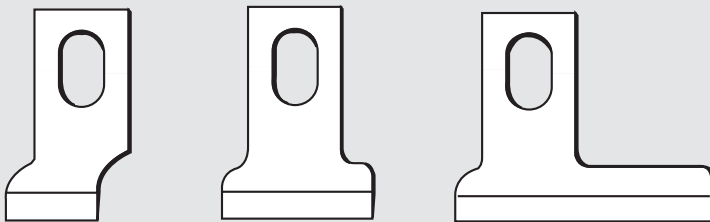

	mm		mm	Zoll
0576005722	8	0556007143	9,5	3/8
0576005723	10	0556007144	11,1	7/16
0576005724	12	0556007146	14,3	9/16
0576005725	14	0556007148	17,5	11/16
0576005726	16	0556007149	19,1	3/4
0576005727	18	0556007151	22,2	7/8
0576005728	20	0556007152	23,8	15/16
0576005729	22	0556007157	31,8	1 1/4
0576005730	24			
0576005731	26			

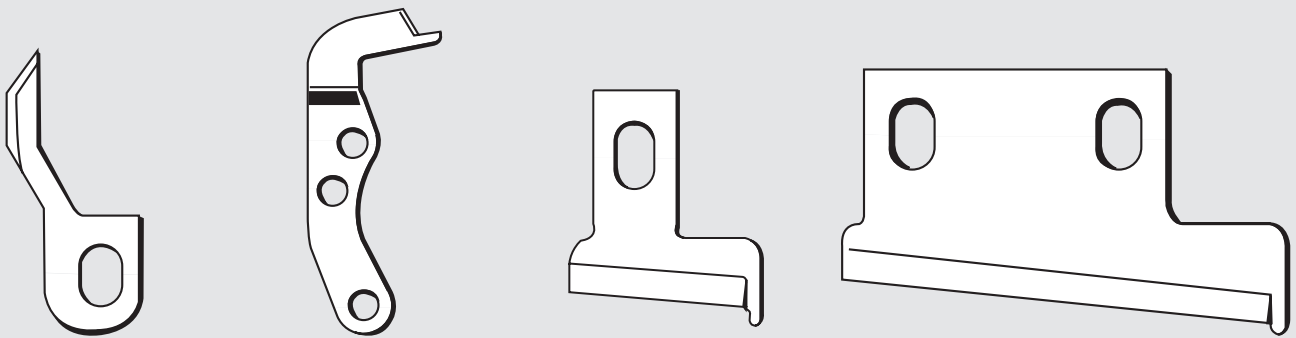

0540330110

0556013536

0556012783

0556012772

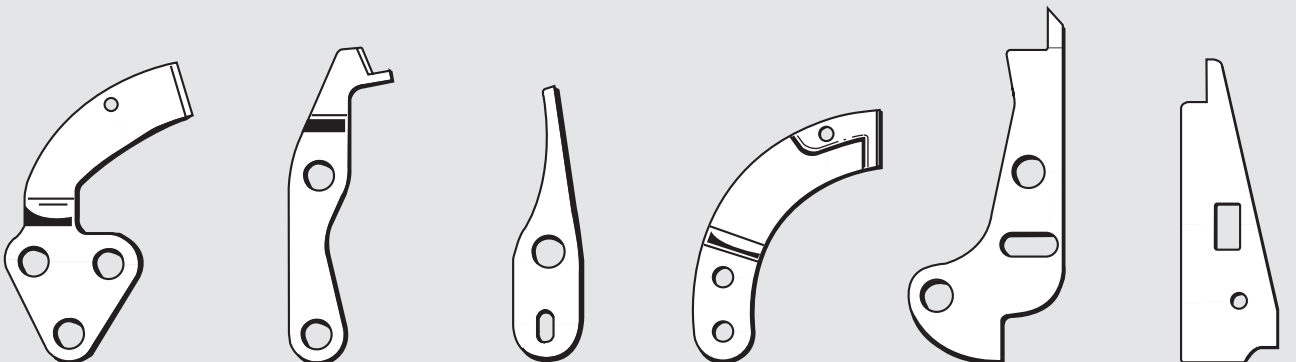

0577350230

0577350240

0577350080

0540350290

0540350340

0540350350





## 557, 558, 559, 578, 579, 580, 589



0557002872  
(557605)  
Bohrung 0,6



0557002872 A  
Bohrung 0,8



0557003243  
Bohrung 0,9



0557000602 A

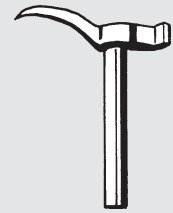

0557000611



0558009011

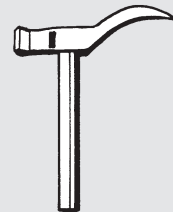

0557002876 K  
(557614)

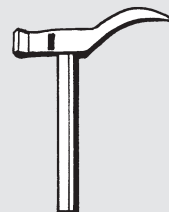

0557002035

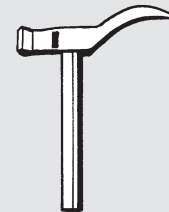

0557003398

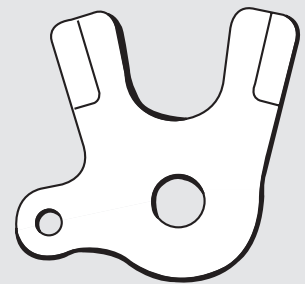

0557000593

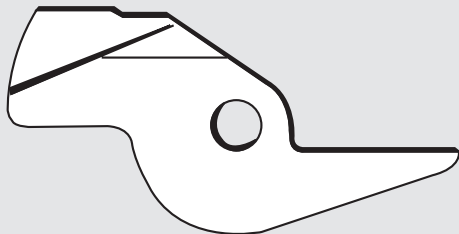

0558006110

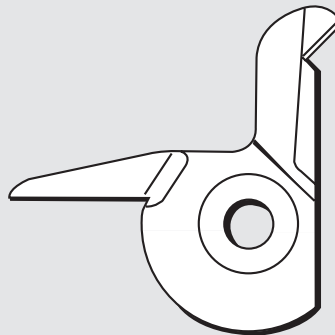

0558006109

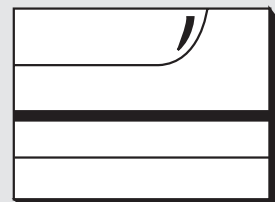

0557001684 MS  
0557001686 MS

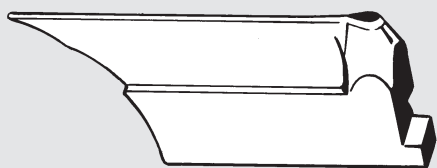

0558002561  
0558002562  
0558002566

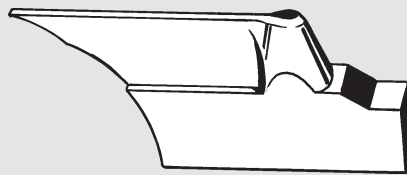

0558002564  
0558002565  
0558002567

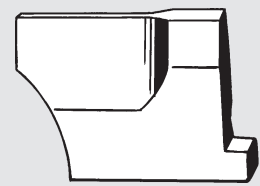

0558002405 16 mm  
0558002406 18 mm  
0558002408 22 mm  
0558002410 26 mm  
0558002411 28 mm



**557, 558, 559, 578, 579, 580, 589**

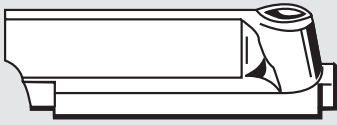

0578003363

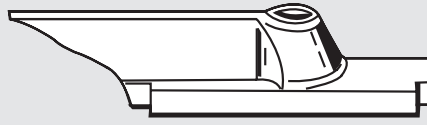

0578003365

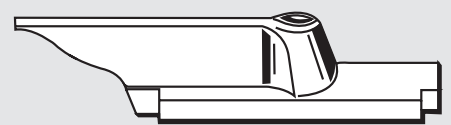

0578003366

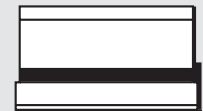
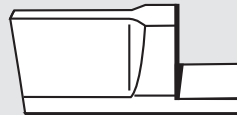
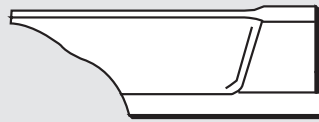
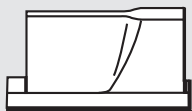

- 0578003281 10 mm
- 0578003282 12 mm
- 0578003283 14 mm
- 0578003284 16 mm
- 0578003285 18 mm
- 0578003286 20 mm
- 0578003287 22 mm
- 0578003288 24 mm

- 0578003289 26 mm
- 0578003290 28 mm
- 0578003291 30 mm
- 0578003292 32 mm
- 0578003293 34 mm
- 0578003295 38 mm

- 0578003323 20 mm
- 0578003324 22 mm

- 0578003304 12 mm
- 0578003308 20 mm
- 0578003309 22 mm
- 0578003311 26 mm
- 0578003314 32 mm
- 0578003315 34 mm
- 0578003316 38 mm

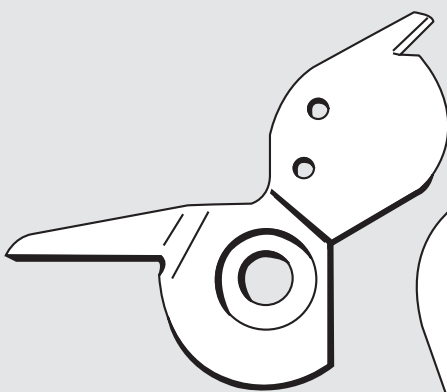

0558008816



0558008817

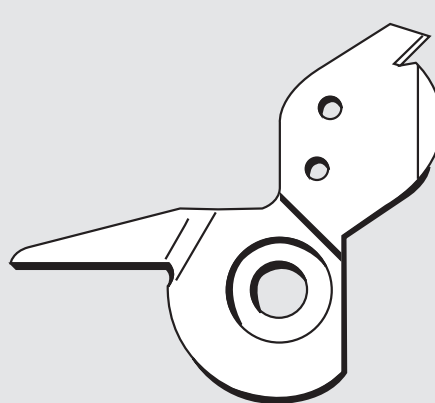

0558008858



0558008859

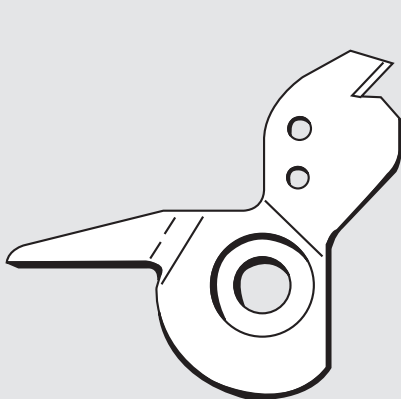

0558008868



0558008869

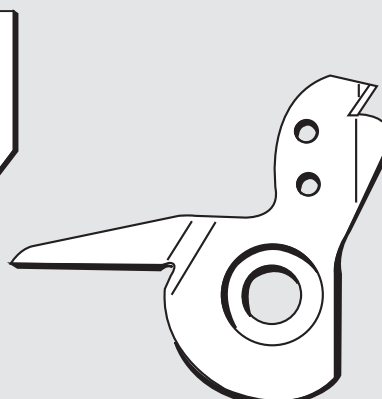

0558008878

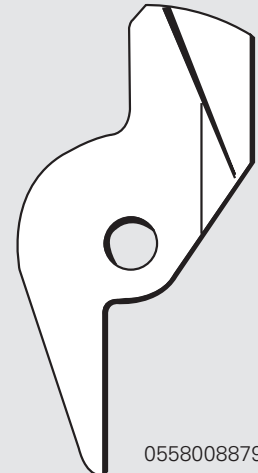

0558008879



580



0558002552

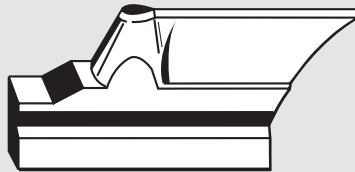

0558006855

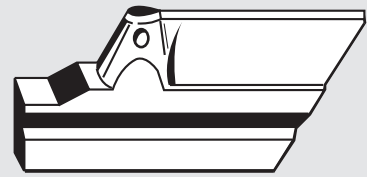

0580330370



0580330390

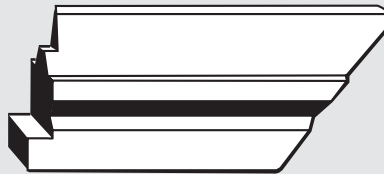

0580330400

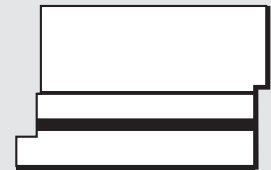

0580330300



0580350280

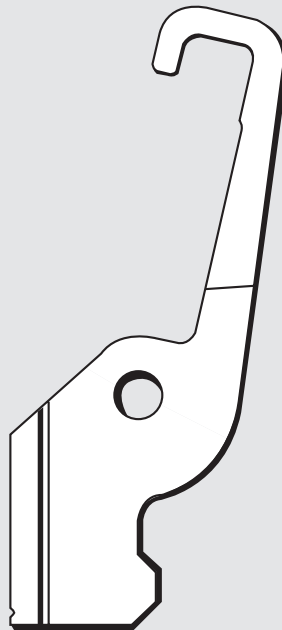

0580350270

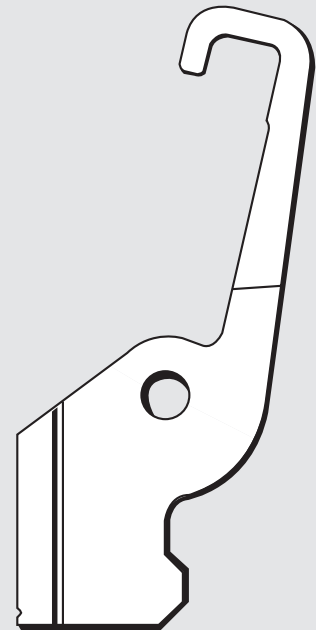

0580350970

669, 869



0659350110

887, 887 M



0887200090



0887200150



0887330010



**745, 746, 748, 749, 745-34 S  
745-21, 745-22**



0246002553

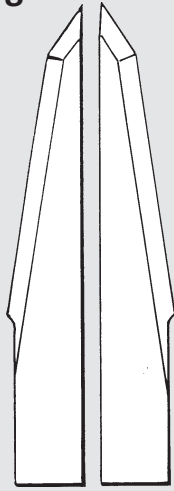

0746060689 0746060690

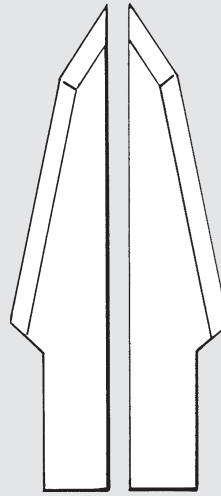

0746060691 0746060692

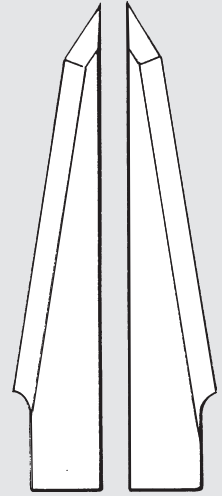

0746000995 A 0746000995

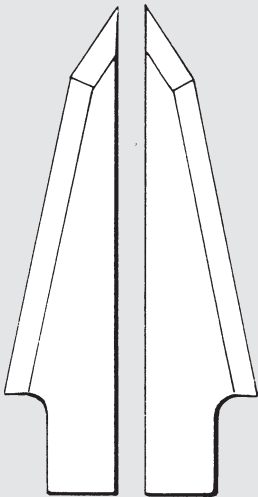

0746000996 A 0746000996

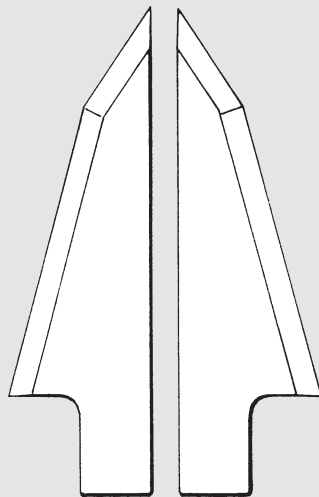

0746000997 A 0746000997



0748000419

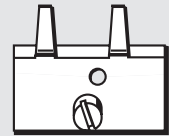

0246002401

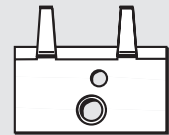

0246002402

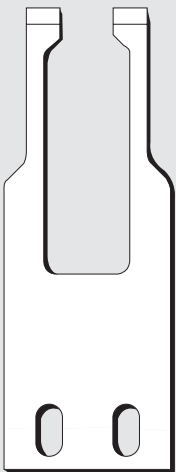

0246350040

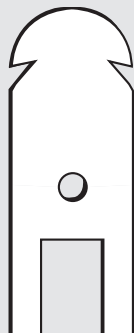

0246350060

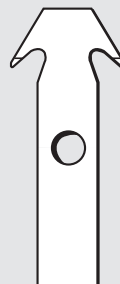

0246000595

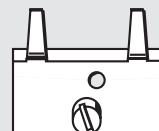

0246002408

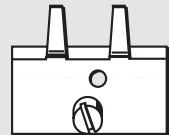

0246002405



## Beisler

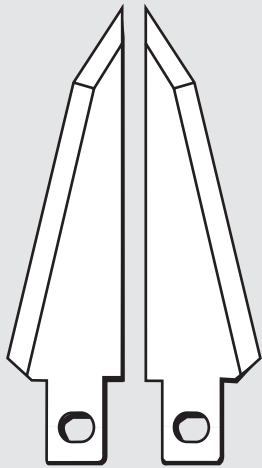

004538.00 004537.00

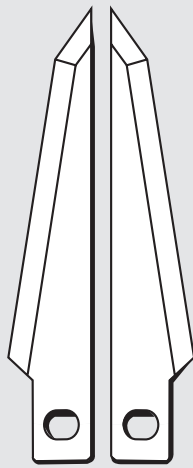

004540.00 004539.00



2500895.00



008688.00

## 867



0867210430

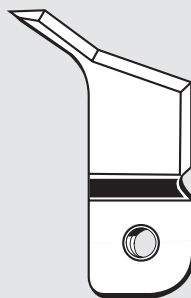

0867330270



0867330280



0867330430

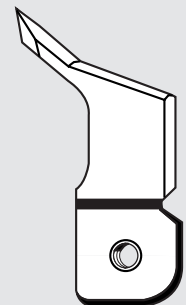

0867330570

## 1296

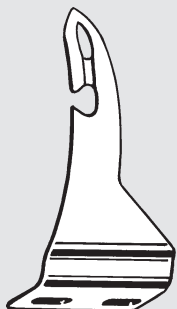

0129175540



0129171853

## 510, 530, 910

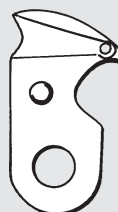

0510 B 2421-280-0A0

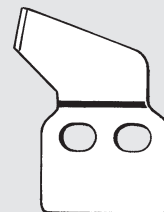

0510 B 2424-280-000



0510350060



**3000**



0793027524

**971**



0971440140



0971440180

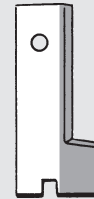

CT 971440140

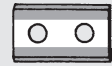

CT 971440180

**4120 i, 4180 i, 4181 i, 4182 i, 4182 i - 147  
4220 i, 4280 i  
888**

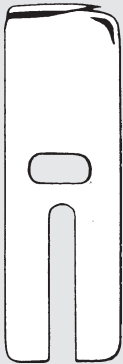

S 425311020 = 2,7

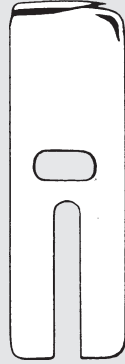

S 425311020 HSS = 2,7



S 425311023



S 425311024



S 425311018



S 425311018 HSS



S 425311021



S 425311021 HSS

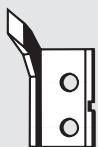

S 080870223



S 080870238



S 080870239



S 425870237  
Solid carbide  
Metal solide duro

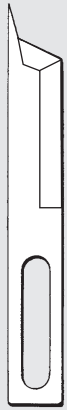

21-5602  
KI. 1010/1020:  
520087  
KI. 2001:  
6502114  
PL-2-13



21-3002  
21-4012  
520018  
PL-2-30 (CT)



21-4587  
512035



21-3003  
650704  
527013  
PL-9-9  
HSS



15487  
21-3003-01  
6507044  
Ceramic



21-4001  
520002  
KI. 1005F/1005FZ



21-3004  
512018  
KI. 1002



MS 3-017 L

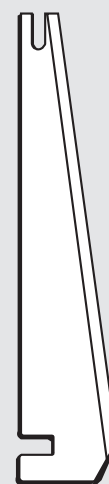

MS 3-017 R

MUSASHI-21



**MO 800 Series, MO 1500 Series  
MO 2000, 2400, 2500 Series, MO 3300, 3600, 3700, 3900 Series  
MOC 3904, 3914 = Union SP 100  
MOR, MOJ 3916  
MO 6100 Series, MO 6700 Series, MO 6800 Series, MO 6900 Series**

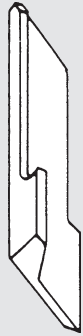

B 4111-804-000

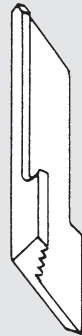

B 4111-804-00D

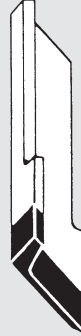

B 4111-804-00A (CT)

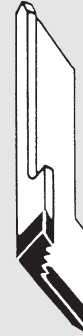

B 4111-804-00E (CT)

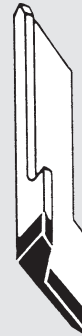

B 4111-804-00C (CT)



B 4118-804-000



B 4118-804-00C



CT B 4118-804-000



CT 118-45906

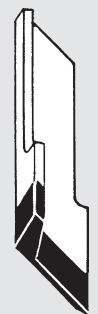

CT 118-45807



CT 118-45807 G



115-65900 (CT)



118-45609 (CT)



118-47407



118-45708 (CT)



118-47506





**MO 800 Series, MO 1500 Series**  
**MO 2000, 2400, 2500 Series, MO 3300, 3600, 3700, 3900 Series**  
**MOC 3904, 3914 = Union SP 100**  
**MOR, MOJ 3916**  
**MO 6100 Series, MO 6700 Series, MO 6800 Series, MO 6900 Series**



120-04909 (CT)



124-45508 (CT)



131-50503 (CT)



131-50602 (CT)



118-46003



118-97501



115-98406



115-66502



122-20307

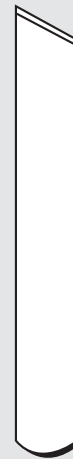

124-47504



131-50701

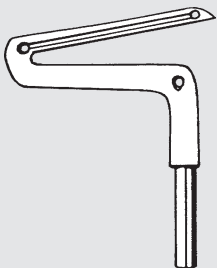

B 2521-804-000

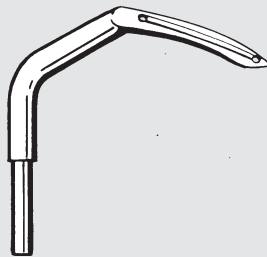

B 2118-816-000

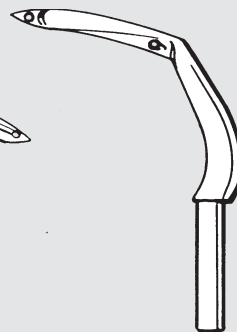

115-39202



B 2519-804-000



B 2519-814-000

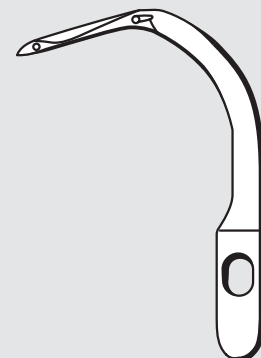

700-00473



**MO 800 Series, MO 1500 Series  
MO 2000, 2400, 2500 Series, MO 3300, 3600, 3700, 3900 Series  
MOC 3904, 3914 = Union SP 100  
MOR, MOJ 3916  
MO 6100 Series, MO 6700 Series, MO 6800 Series, MO 6900 Series**



115-44806



116-81301

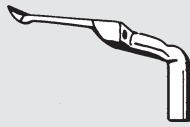

118-88005



118-88104



118-88203



118-88302

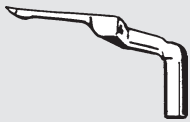

118-88609

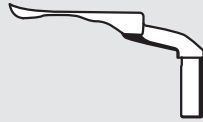

700-00798

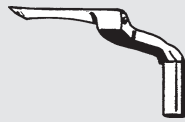

119-91908

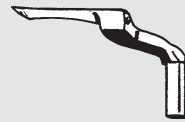

119-93607

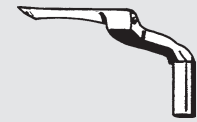

119-99208

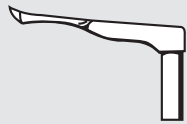

120-14908

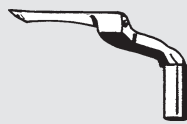

121-76004

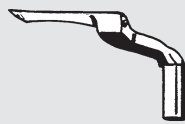

121-76103

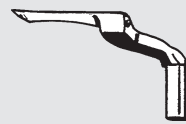

121-76202

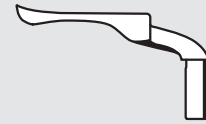

700-00799



122-47508



123-83501



123-83600

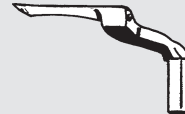

124-81107

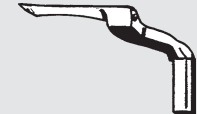

124-81008

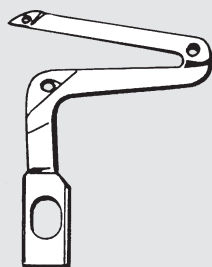

118-88401

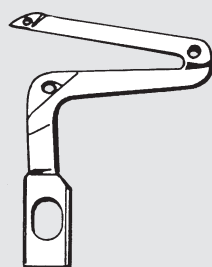

118-88500

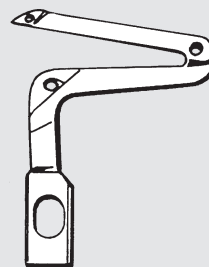

118-88501

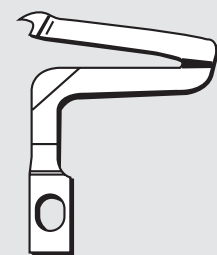

118-88708



**MO 800 Series, MO 1500 Series  
MO 2000, 2400, 2500 Series, MO 3300, 3600, 3700, 3900 Series  
MOC 3904, 3914 = Union SP 100  
MOR, MOJ 3916  
MO 6100 Series, MO 6700 Series, MO 6800 Series, MO 6900 Series**

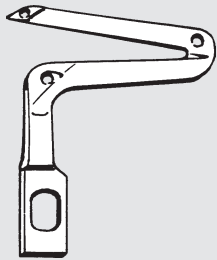

118-89904

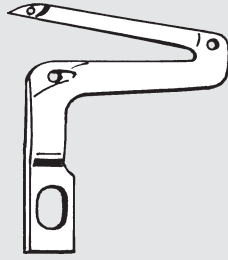

119-99307

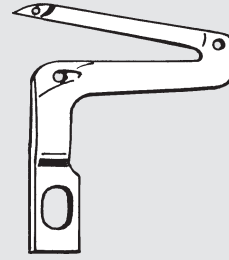

119-99802

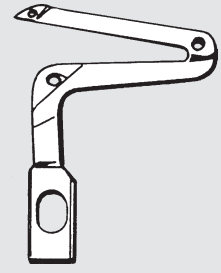

122-40107

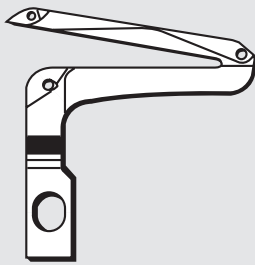

123-84202

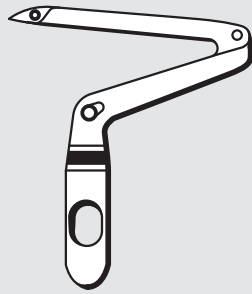

700-00405

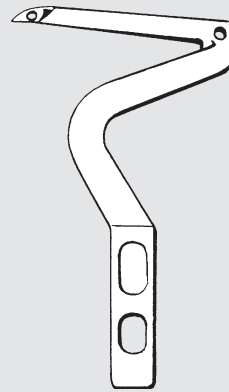

124-81800

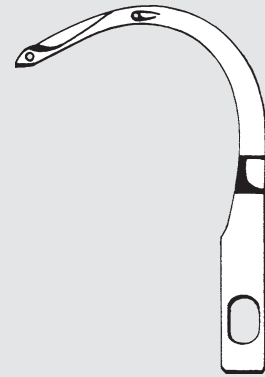

124-82600

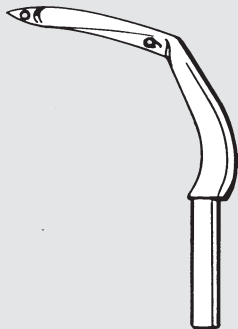

118-29405

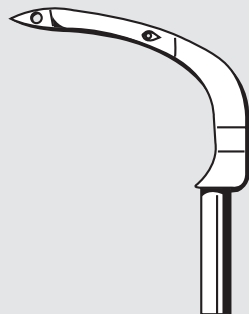

120-03604

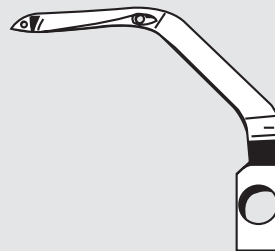

121-20705

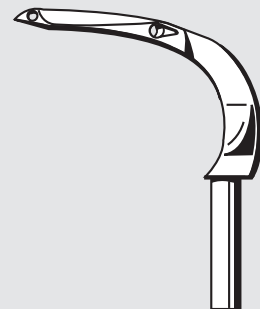

123-84400



**MO 800 Series, MO 1500 Series  
MO 2000, 2400, 2500 Series, MO 3300, 3600, 3700, 3900 Series  
MOC 3904, 3914 = Union SP 100  
MOR, MOJ 3916  
MO 6100 Series, MO 6700 Series, MO 6800 Series, MO 6900 Series**

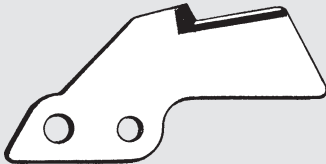

MAT-0220 3000 (CT)  
T 022, T 035

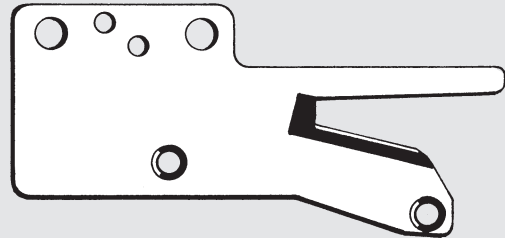

MAT-0220 4000 (CT)  
T 022, T 035

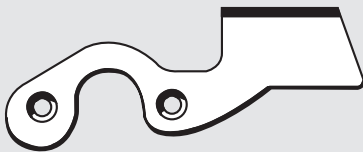

MAT-0350 6000 (CT)

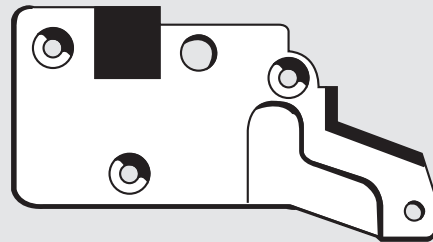

MAT-0350 5000 (CT)

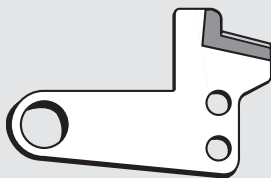

MAT-0360 6000 (CT)

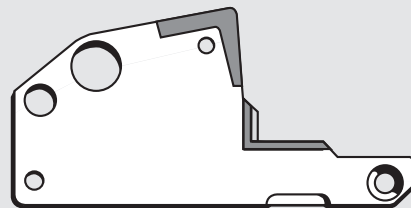

MAT-0360 500A (CT)

**MH 1410**

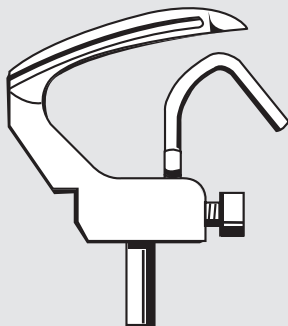

311-54503

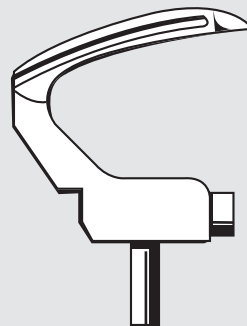

311-54602



**MO 102, 103, 104, 202, 204, 234, 305, 335 Bernette**



B 4108-352-00D (CT)



A 4113-102-000



A 4142-335-000 (CT)

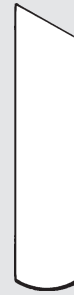

A 4145-335-000

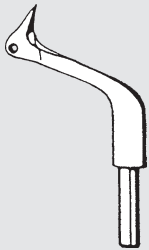

A 2512-102-000

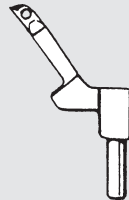

A 2512-103-000

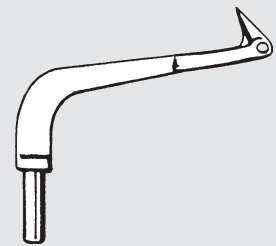

A 2511-202-000

**MO 352, 357**



B 4108-352-00D (CT)

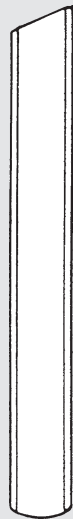

B 4122-352-00 A

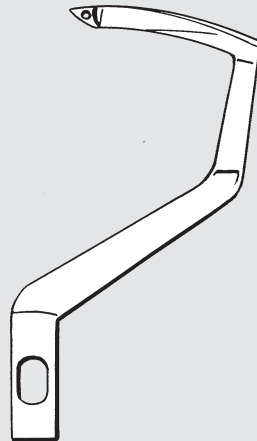

B 2011-357-000

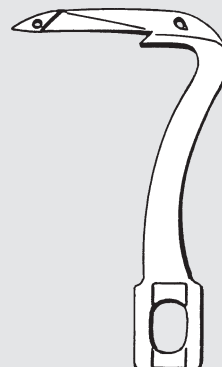

B 2521-352-000

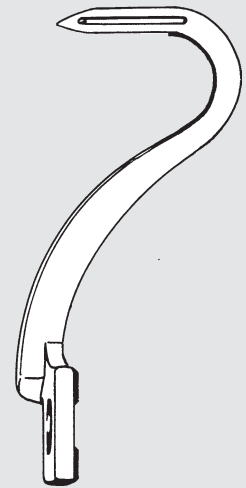

B 2520-352-000

**PLW 1257**



106-46909



106-50703



**AMS Series  
LK Series  
MOL 254**



138-81255

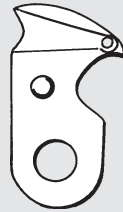

B 2421-205-0A0



B 2421-210-000



B 2421-210-AA0

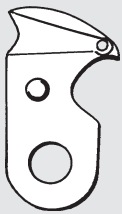

B 2421-280-0A0



B 2424-210-000



B 2424-210-A00

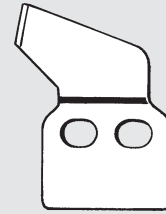

B 2424-280-000



CT B2424-280-000

**DDL 555, 5550, 5570, 5580, 5600, 5700, 9000, 9000 A, 9000 B  
DDL 850-7, 8500-7, 8700-7, 8700 H  
DLN 415, 5410, 6390-7, 9010, 9010A  
DLD 5430  
DLU 5490 N-7**

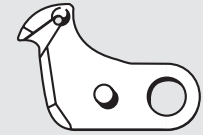

110-40052



D 2402-555-BA0



D 2402-555-BAB

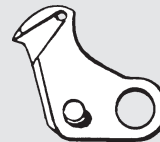

D 2402-415-BA0

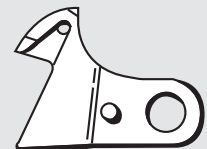

114-09257

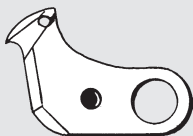

110-93259

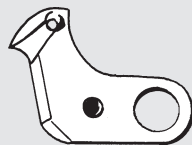

113-13053

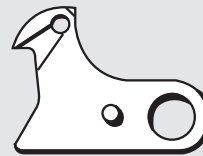

114-08150

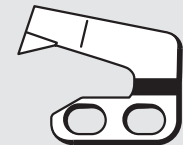

400-89755

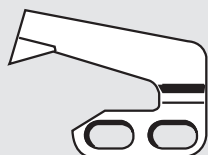

114-09604

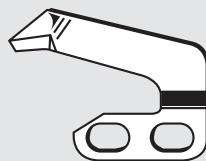

400-00324

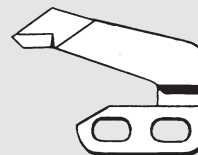

D 2406-555-B00

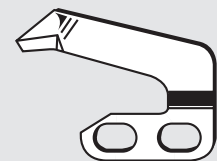

D 2406-555-D0H



**LU Series**



107-26404



213-89309

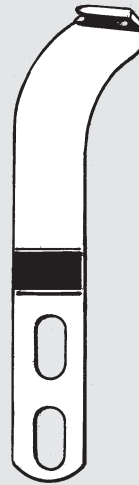

107-26305

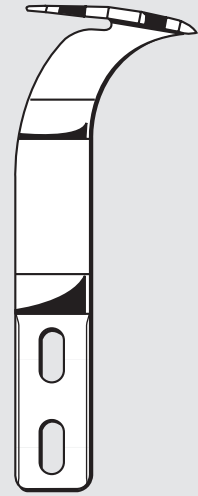

213-89200

**MH 481, 484**

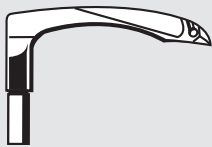

B 2030-481-000

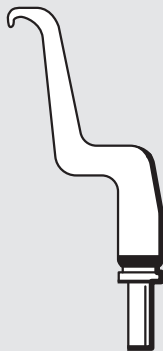

B2126-481-0A0

**LH 1152, 1162, 1164**

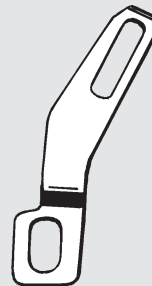

102-11209

**LH 3500, 3500 A  
LH 3528, 3568  
LH 4128, 4168**



400-12404



400-12403

**LH 3120, 3126, 3128, 3162, 3178,  
3182, 3188**

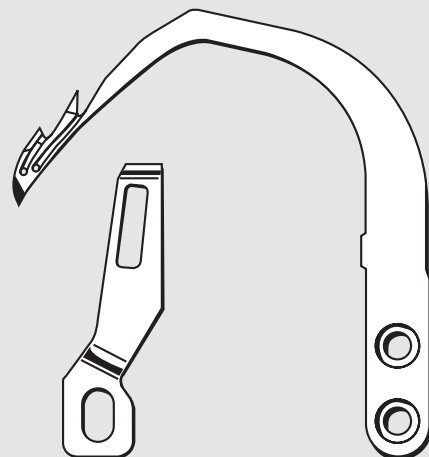

226-55302

102-11605



**DLM Series  
DMN Series**

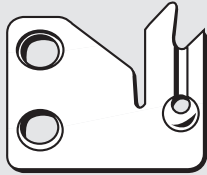

113-51400



113-51509



B 4121-052-A00



B 4121-522-000

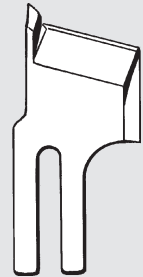

B 4145-530-B00

**MF 850, 860, 880, 890, MF 2600, MFB 860, MFB 2600**

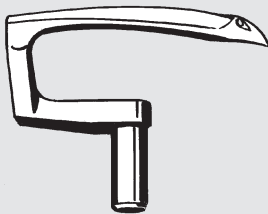

B 2514-860-G00



MAS-11012-000



MAS-11013-000

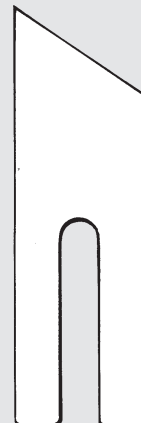

MAS-11016-000

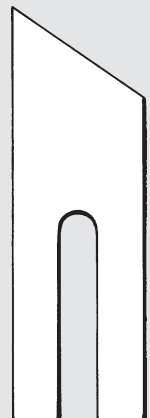

MAS-11017-000

**MF 7500, MF 7500 D Series**

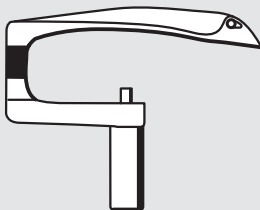

133-37902

**MH 380, 382**

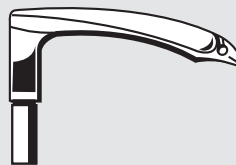

B 2030-380-000

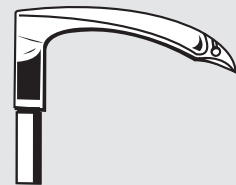

B 2031-380-000

**MF 7000, MFC 7000**

siehe Union CS/FS 100 Seite 108  
see Union CS/FS 100 page 108  
véase Union CS/FS 100 Página 108

**MF 7600, 7700, 7800  
MF 7200 D  
MF 7800 D**

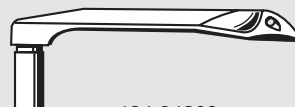

134-24809





MS 1190, MS 1261, MS 1261 V 045, MS 1261 M, MS 1261 M V045

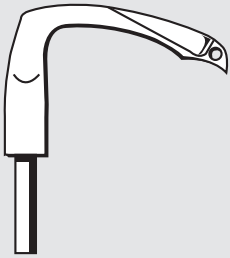

129-68509 (L)

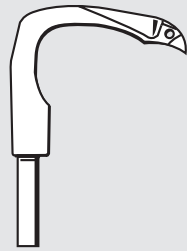

129-68806 (R)

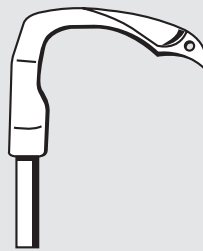

129-69101 (C)

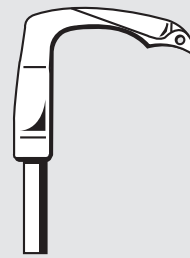

129-79308 (C)

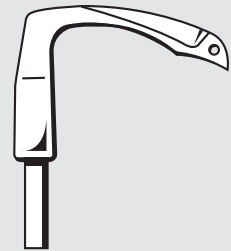

129-79209

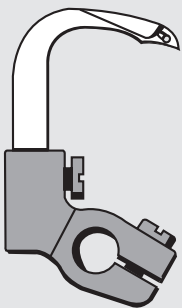

129-41050

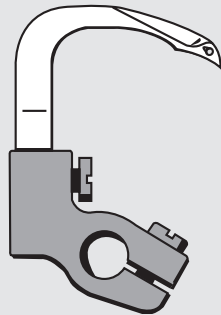

129-41852

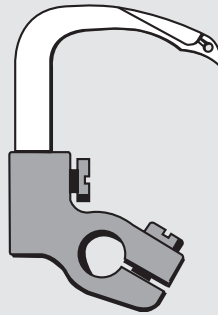

129-41951

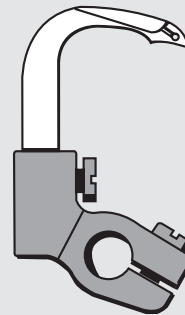

129-40557

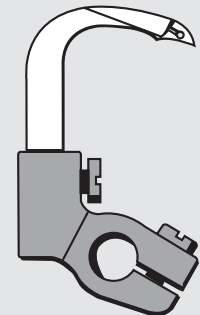

129-40953

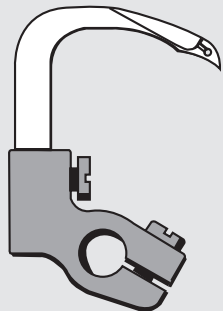

129-41456

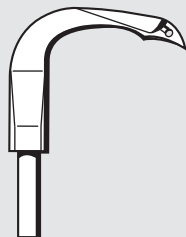

129-40508

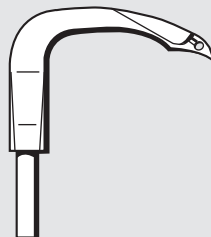

129-41407

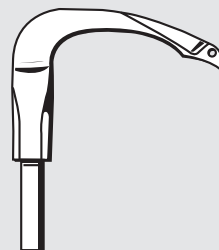

129-41555

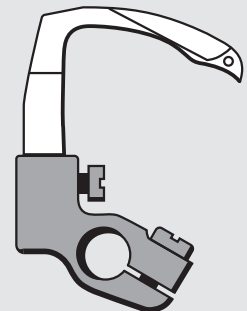

129-68558

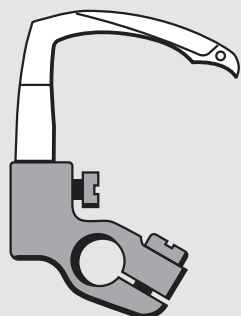

129-68657

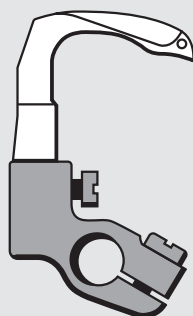

129-68855

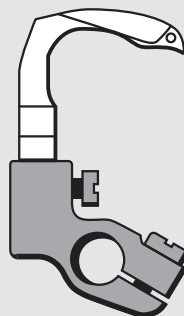

129-68954

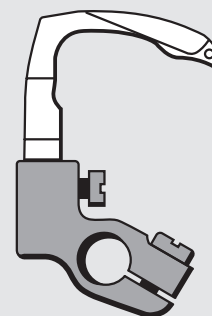

129-69150



**DU 141 H-7**

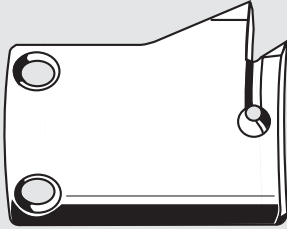

D 2423-141-E00



D 2424-141-E00

**PLC 1610, 1660**

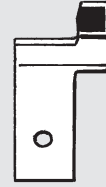

230-05903



230-05804

**APW Series**



164-16109  
164-18600  
SUPER-Stahl  
SUPER-steel



164-18709  
164-18006  
SUPER-Stahl  
SUPER-steel



254-43805  
SUPER-Stahl  
SUPER-steel



254-46808  
SUPER-Stahl  
SUPER-steel



166-07400  
SUPER-Stahl  
SUPER-steel



166-07301  
SUPER-Stahl  
SUPER-steel



166-07608  
SUPER-Stahl  
SUPER-steel

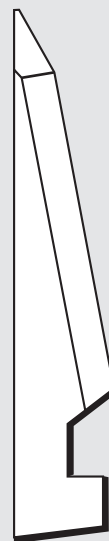

166-07509  
SUPER-Stahl  
SUPER-steel

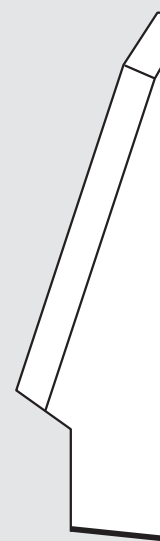

166-07806

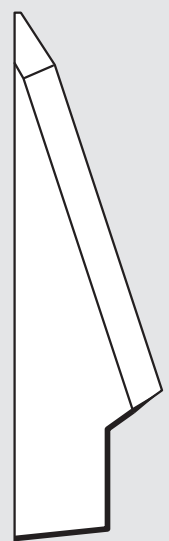

166-07707



LBH 761-763, 771-773, 781-784, LBH 793  
LBH 1700, LBH 1790, LBH 781NS  
ACF 172-1790

= Singer Kl. 71

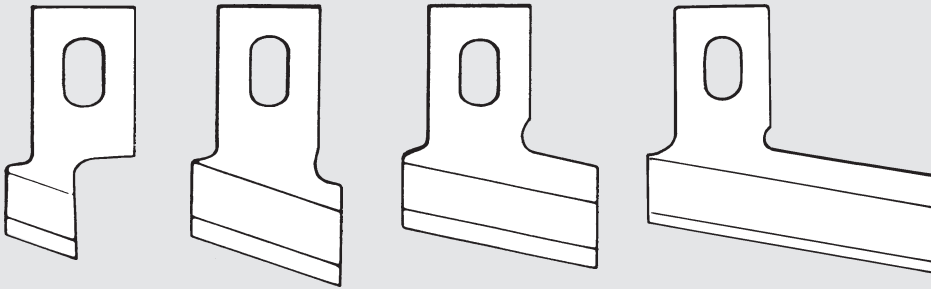

**HSS=**  
**High Speed steel**  
**Acero rápido de**  
**alto rendimiento**

B 2702-047-F00	1/4"
B 2702-047-K00	3/8"
B 2702-047-I00	7/16"
B 2702-047-L00	1/2"
B 2702-047-V00	9/16"
B 2702-047-M00	5/8"
B 2702-047-A00	11/16"
B 2702-047-N00	3/4"
B 2702-047-P00	7/8"
B 2702-047-Q00	1"
B 2702-047-S00	1 1/4"
B 2702-047-R00	1 1/8"

= Singer 71-90

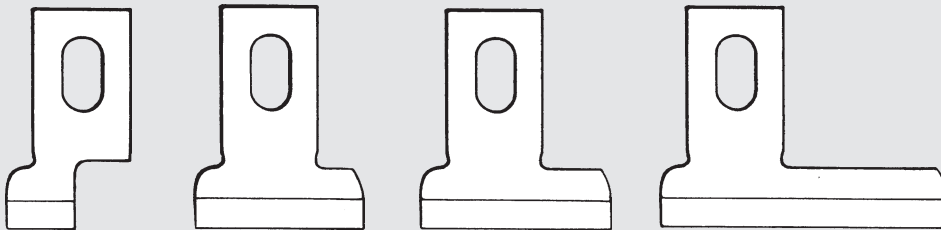

B 2745-771-F00	1/4"
B 2745-771-K00	3/8"
B 2745-771-L00	1/2"
B 2745-771-H00	9/16"
B 2745-771-M00	5/8"
B 2745-771-N00	3/4"
B 2745-771-P00	7/8"
B 2745-771-Q00	1"

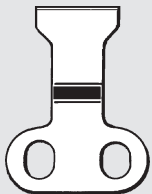

B 2408-761-000

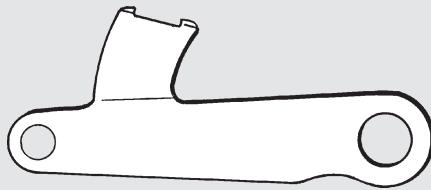

B 2406-761-0A0



B 2408-771-000

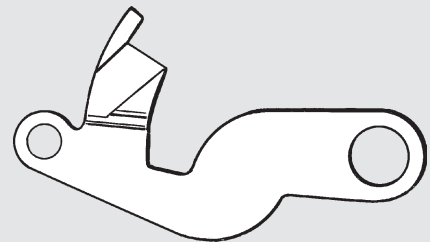

B 2406-771-0A0

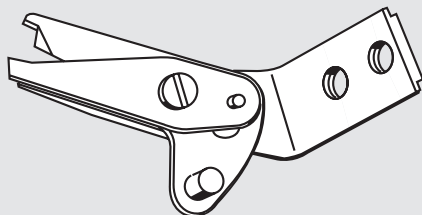

B 2001-771-0A0

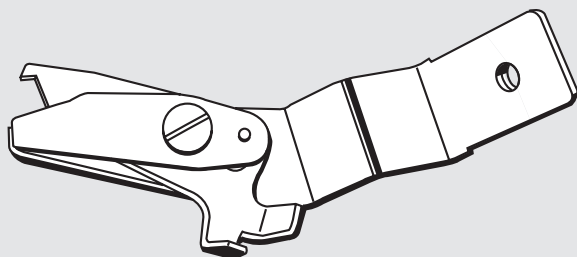

400-04255



**MBH 180, MEB 1890 = Reece S 200**

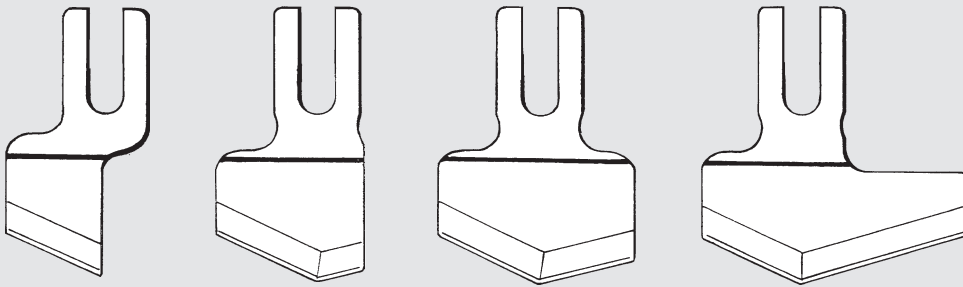

B 2701-180-F00	1/4"
B 2701-180-K00	3/8"
B 2701-180-L00	1/2"
B 2701-180-V00	9/16"
B 2701-180-M00	5/8"
B 2701-180-N00	3/4"
B 2701-180-P00	7/8"
B 2701-180-Q00	1"
B 2701-180-R00	1 1/8"
B 2701-180-S00	1 1/4"
B 2701-180-T00	1 3/8"

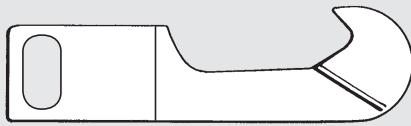

B 4002-180-000



B 1109-180-000



B 4001-180-000



B 2523-180-000



B 2524-180-000

**LZ 2280, 2282, 2282 N, 2282 NU, 2286 NU, 2288 NU, 2290**

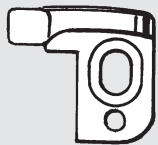

235-06009

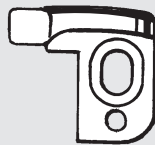

CT 235-06009



225-57706



225-57557

**ML 111 U**

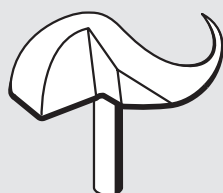

B 1830-111-000

**MB 372, 373, 377, 1370, 1373, 1377, 1800  
AMB 289**



B 1239-372-000

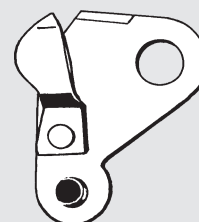

B 2406-373-0A0



B 2410-373-000



MEB 2688, 3200



140-30803



140-30902



320-40800



400-15694

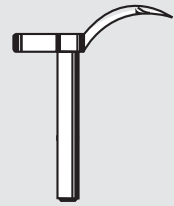

140-31017

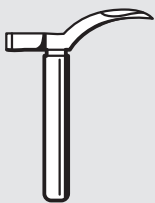

320-40917

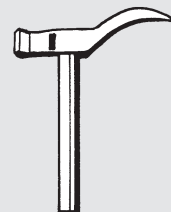

140-31108



140-31116

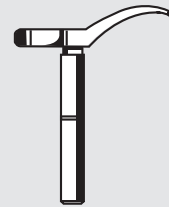

400-15684



400-15685

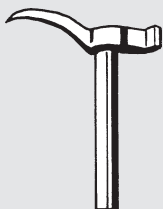

140-31009



400-15693

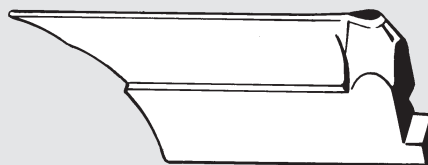

140-41206



320-23319



320-18012

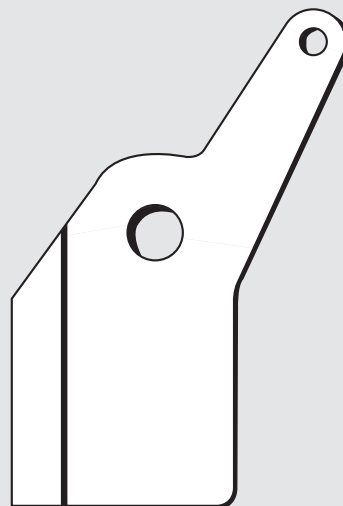

320-20505

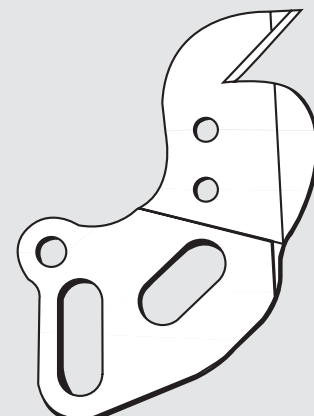

400-15996



**Babylock**

**EF 205, 405, 406, 434, 436, 605, 738**  
**BL 3-408, 418**  
**BL 4-605**

**SL 330, 500, 800, 803, 843**  
**BL 3200**



305249



205-9102-01 A (CT)



305248  
205-9101-01 A



405-9102-01 A



408-9101-01 B



408-9102-01 A



PL-Q11-01 A



PL-Q11-01 C



PL-R11-01 A



SE-R11-01 A



B4401-04A-0Y

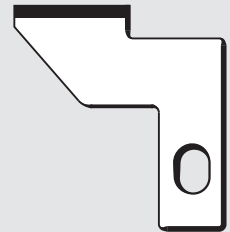

B4471-02A-0Y

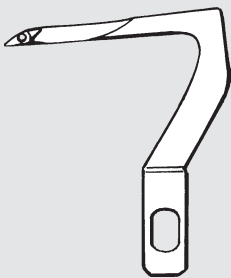

418-6101-02 A



714-6101-01 A



60507 (CT)



60544



B4401-03A-0Y

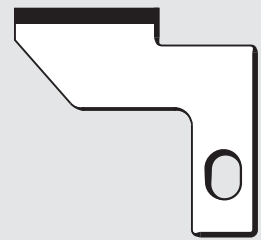

B4471-03A-0Y



**DPW-1300 / PX-302  
V 7102 ML**

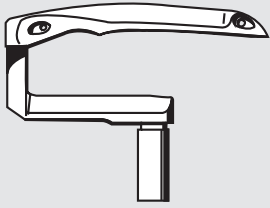

19-351

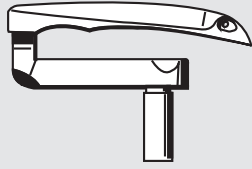

19-353

**DFB  
BX**

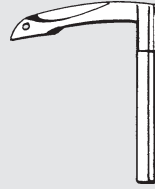

19-431



19-437

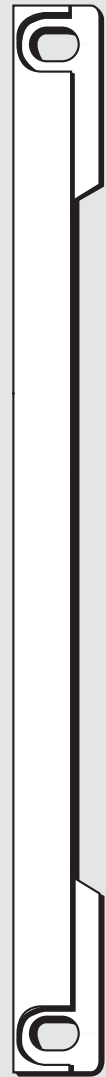

05-429

**DLR**

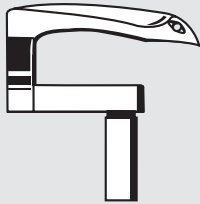

19-512

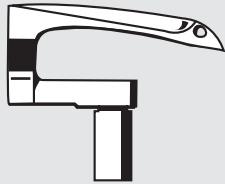

19-514

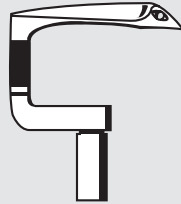

19-518

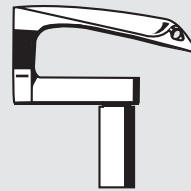

19-521

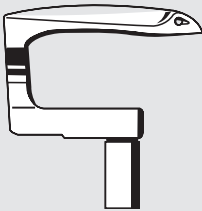

19-522

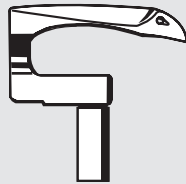

19-546

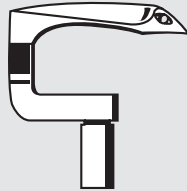

19-547

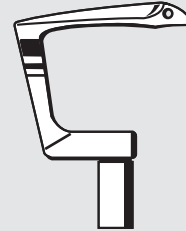

19-548

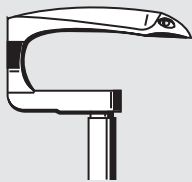

19-535

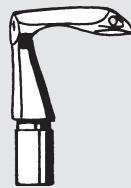

19-581



19-582

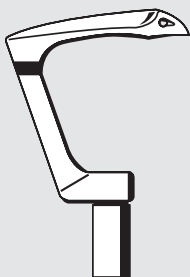

19-549



19-583

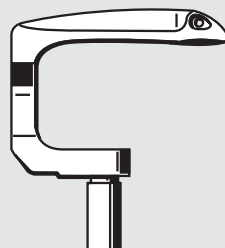

19-536

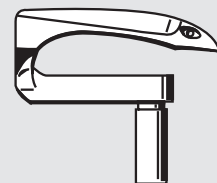

19-531



**DVK 1700  
DVK 3200**

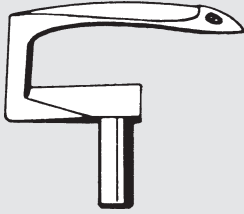

19-703-0

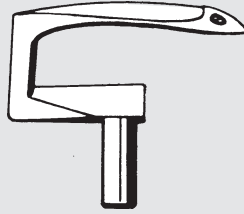

19-712

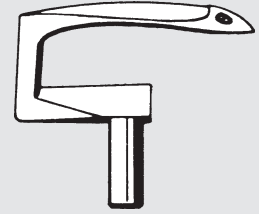

19-713



07-406 (CT)

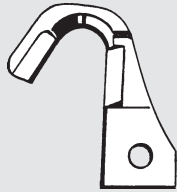

07-124 (CT)



07-206

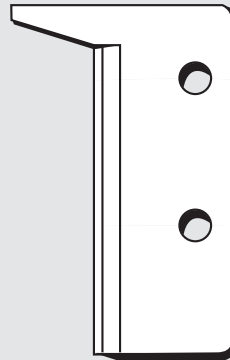

52-275

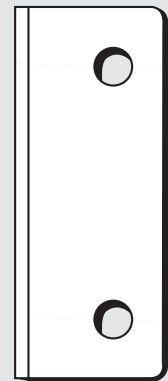

52-288

**DVK 1700  
DVKB-2000  
BLX 2200**

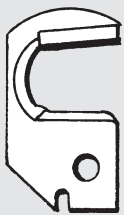

07-702 (CT)



07-703 (CT)

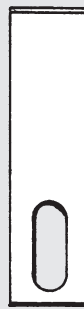

07-707

**W 8100**



07-168  
07-170



07-169





**W 8002, 8003, 8103  
V Series  
VW Series**

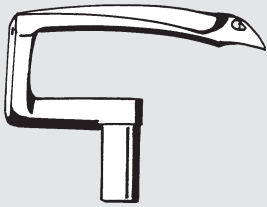

19-801

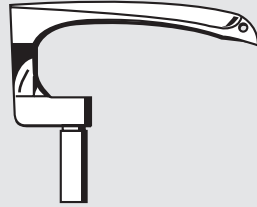

19-814

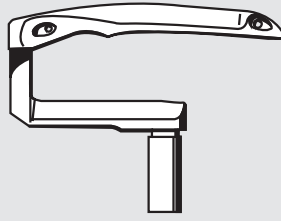

19-351



19-807

**WX, LX, MC 30**



07-558

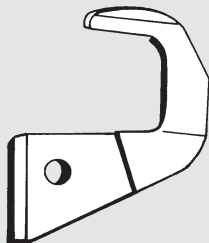

07-570 (CT)



07-507

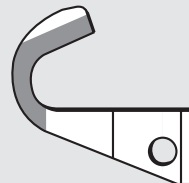

07-505 (CT)



05-812



05-658

**RX-, WX-, BLX Series**

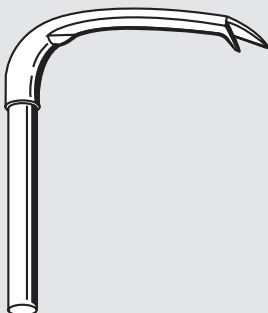

19-505

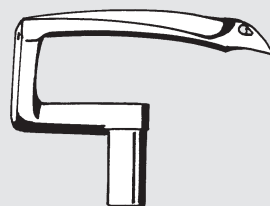

19-539

**DX-, RX Series  
MZ Series**



19-525

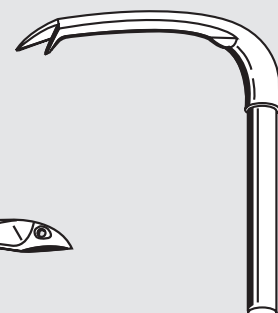

19-505



**SH-6000 Series**  
(Global, Pfaff, Singer usw.)



377462 (CT)  
6031314 C 500

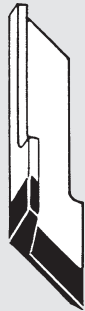

344559 (CT)



377465 (CT)



377559 (CT)  
G 6050113 C 500

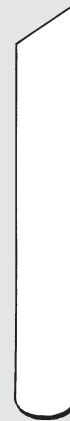

377443  
6031218 P 700



377560  
G 6050114 P 700

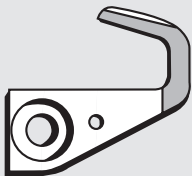

2273110120

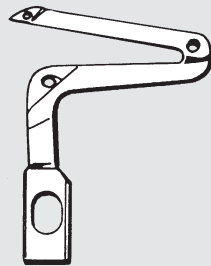

377602  
LL 603884

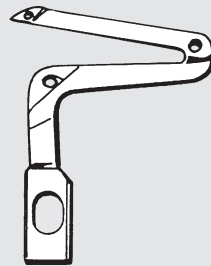

377640  
LL 604885

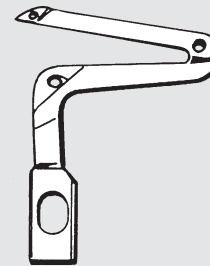

377641  
LL 604884  
LL 600884

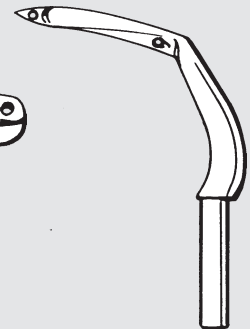

UL 605294

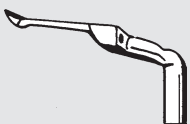

377600 (A)  
UL 603880  
UL 600880

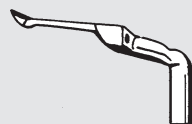

377601 (C)  
UL 603886  
UL 600886

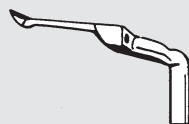

377638 (D)  
UL 604883  
UL 600883

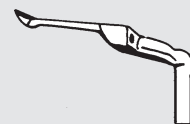

377639 (F)  
GUL 604152

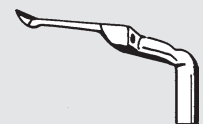

377740 (B)  
UL 603881  
UL 600881



Baureihe 10, 40, 50

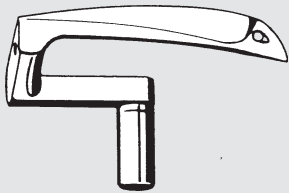

96-712082-05  
Kl. 10, 50



96-705142-05

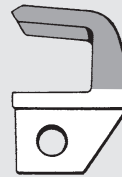

CT 705142



96-700591-05 (HSS)  
CS 816



CT 700591



96-700535-05 (HSS)  
ZA 815



CT 700535

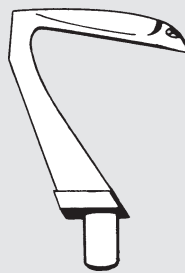

96-700565-05  
CS 37  
Kl. 40

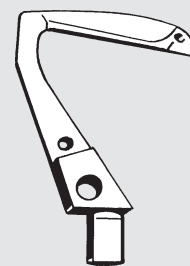

96-722820-05  
Kl. 40



96-701080-05



96-722166-05

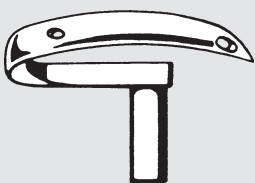

96-702750-05  
AP 37 B

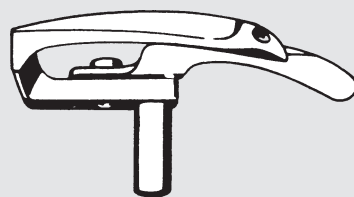

96-702417-91  
AH 37 E

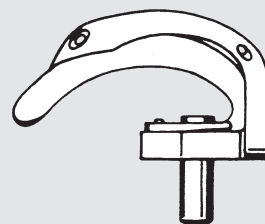

96-706509-05  
CHG 37

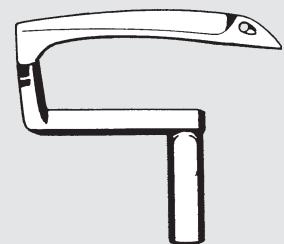

96-710414-05  
F 23100-37 A



Ersatzteile  
aus eigener  
Herstellung

Teile passend für  
Mauser-Nähmaschinen

OAH, ODA usw.

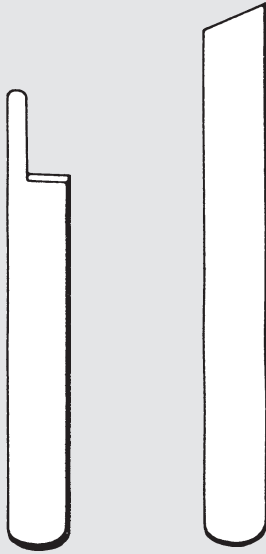

96-705205-05  
JABD 816

96-706135-05  
JABD 815

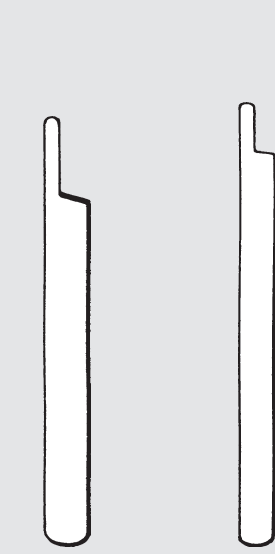

96-707786-05  
JAB 816 A

JC 816

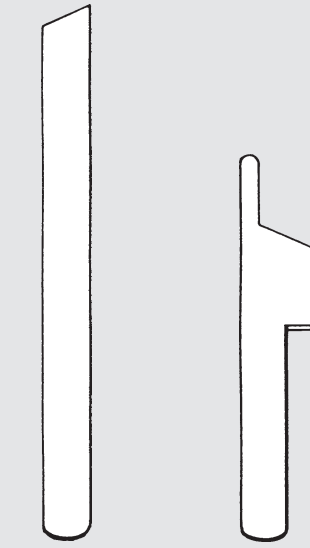

96-706651-05  
JA 815



96-705438-05  
JAB-A 816

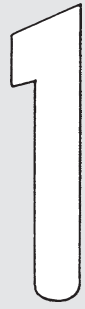

96-705468-05  
JAB-A 815

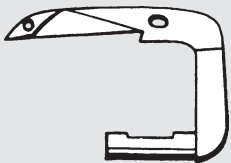

96-702693-05  
J 37 L

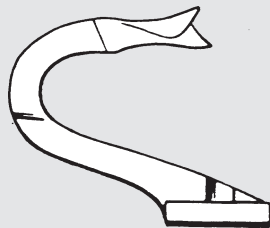

96-702414-05  
JLB 37 R

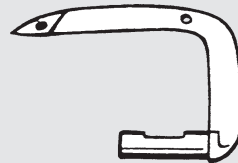

96-702692-05  
JC 37 L

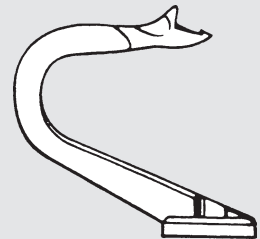

96-702684-05  
JG 37 R

4542, 4562

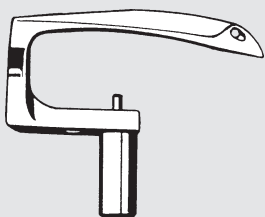

257550-91  
09-400401-00

68



96-795104-00



## S 1323 usw.



96-720745-05  
S 815-8  
720745 (CT)

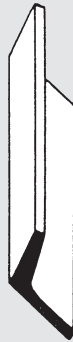

96-720742-05  
SH 816-8



96-720744-05  
SK 816

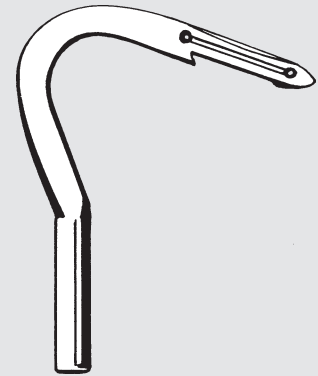

96-720392-05  
S 37 BL

## AG



CAM 315



CAM 316

Teile für Mauser-Overlock / Safety-Maschinen siehe Pegasus.  
Parts for Mauser-Overlock / Safety Machines see Pegasus.  
Piezas para Mauser-Overlock / Máquinas de seguridad véase Pegasus.

Mauser-Klasse	=	Pegasus-Klasse
401	=	L 22
500	=	L
504	=	R 53, R 57
2001	=	S 22
2003	=	S 52
2004	=	S 52
2005	=	S 52
2014	=	S 32
2015	=	S 32
2016	=	S 32
4542	=	W 542
4562	=	W 562
4664	=	W 664
4742	=	W 742

Mauser-Klasse	=	Pegasus-Klasse
4762	=	W 762
9622	=	E 22
9622 L	=	E 22 L
9632	=	E 32
9632 L	=	E 32 L
9651	=	E 51
9652	=	E 52
9652 L	=	E 52 L
9654 A	=	E 54
9656	=	E 256
9732	=	ETS 32
9732 L	=	ETS 32 L
9751	=	ETS 51
9752	=	ETS 52



CT 6-90 D

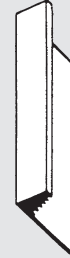

A 90-3



6-91



6-91 E



CT 6-91 E

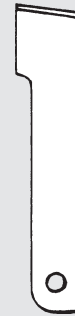

6-91 C



6-91 K



59



72



**DB 130, 189, 199**  
**LS 2-150, 180**  
**LS 190, 210**



MF 16 A 0838

**LG 2-3370, LS-1280**  
**LS 2-180, LS 2-190, LS 2-210**  
**LS 2-1180, LS 2-1280, LS 2-1380, LS 2-1780**  
**LS 2-2210**

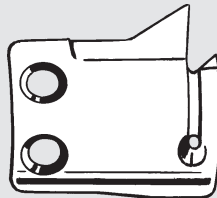

MF 00 A 0834



MF 00 A 0838

**DB-199, LS 2-190**  
**PLK-1210, PLK-2520**

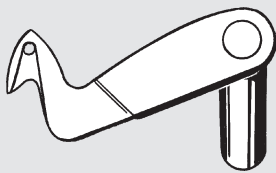

MF 90 B 2838  
MF 90 B 0838

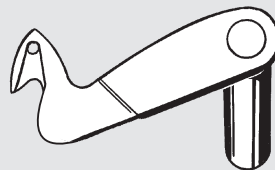

MG 44 B 0838



MF 90 A 0838

**109, 303**



MS 01 B 0838



MS 01 A 0838

**DB 189**

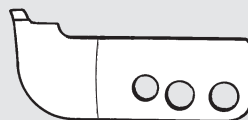

MF 40 A 1835  
MF 40 A 2835

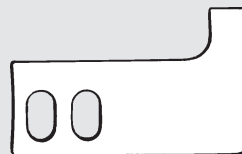

MF 40 A 1834

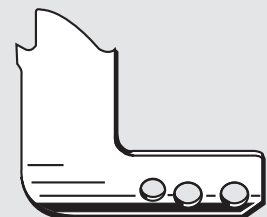

MF 40 A 2180



**LS 2-Series  
LT 2-Series  
LU 2-Series  
LU-Series**



MN 50 A 0838



MP 41 A 0838



MP 41 B 0838  
MN 50 B 0838

**DY 359  
PLK-2520 A  
LY-3310-B1T  
LY-3750-B1T  
LY2-3710-B1T  
LY1-3750-B1T**

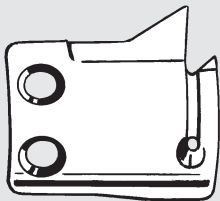

MG 52 A 0834



MG 52 A 0838

**339, 349**



MG 40 B 0834

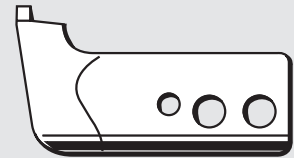

MG 40 B 0835

**PLK-Series  
PLK-E-Series  
PLK-G-Series**



MS 03 B 0838



MS 03 A 0838  
MS 14 A 0838



CT MS 03 A 0838  
CT MS 14 A 0838

**LS 2-180 B1T  
PLK-1410, 1710  
PLK-E 2010R  
PLK-E 2516R  
PLK-G 5045R**

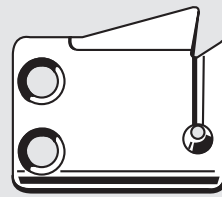

MF 02 A 0834



MS 10 A 0838  
MF 02 A 0838





400-100, 405-100, 458-100

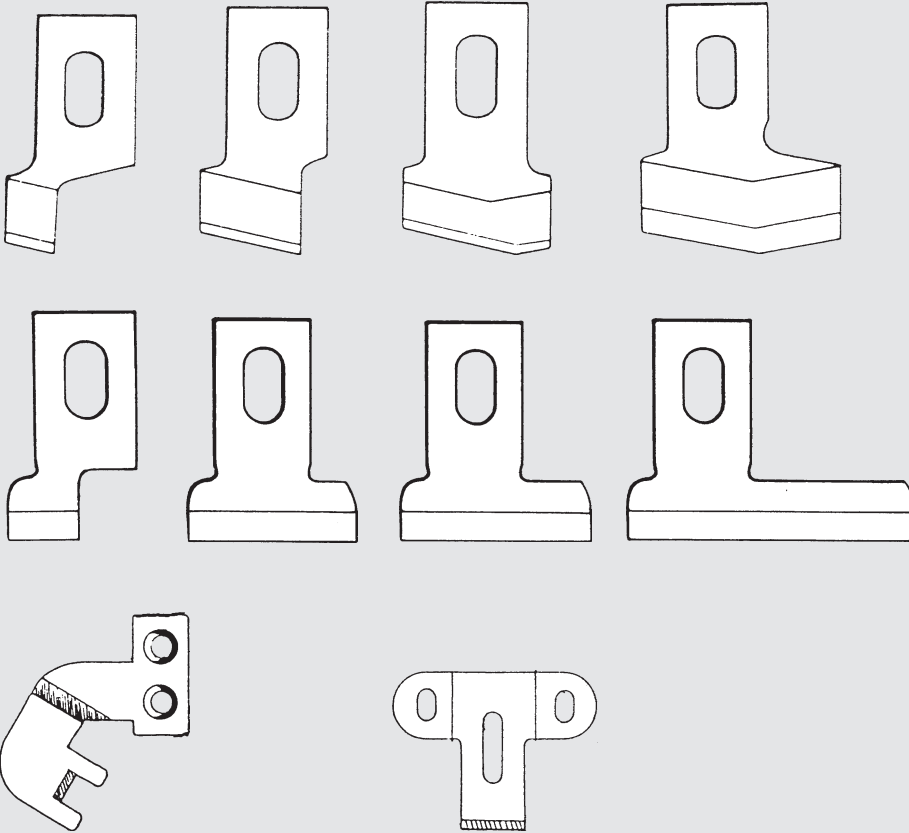

**HSS = High speed steel**  
**Acero rápido de alto rendimiento**

- = Pfaff-No.
- 996448000 = 91-020241 - 6,4
- 996449000 = 91-020241 - 9,5
- = 91-020241 - 11,0
- 996450000 = 91-020241 - 12,7
- = 91-020241 - 14,0
- 996451000 = 91-020241 - 16,0
- = 91-020241 - 17,5
- 996452000 = 91-020241 - 19,0
- = 91-020241 - 20,0
- 996453000 = 91-020241 - 22,2
- 996454000 = 91-020241 - 25,4
- 996455000 = 91-020241 - 28,6
- 996456000 = 91-020241 - 31,7
- = 91-020241 - 33,3
- = 91-020241 - 36,5
- 996458000 = 91-020241 - 38,1
- = 91-020241 - 39,7

- 120748 - 6,4
- 120748 - 9,5
- 120748 - 11
- 120748 - 12,7
- 120748 - 14
- 120748 - 16
- 120748 - 17,5
- 120748 - 19
- 120748 - 22,2
- 120748 - 25,4

154851000

154852000

835-261, 263  
885-261, 263  
UAN 2641 / 2661

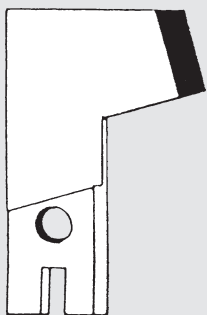

186188202 (CT)

UAN 1700, 1701

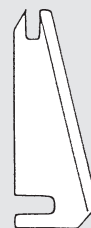

181814003

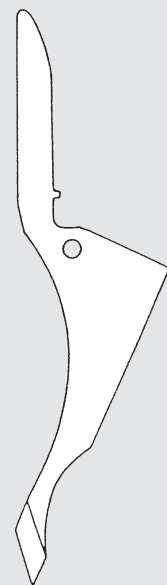

181812000 (HSS)



**DCR 601, 801, 901, 905**  
**E22, E22L, E32, E32L, E51, E52, E52L, E54, E256**  
**ETS32, ETS32L, ETS51, ETS52**  
**EX/EXT 3200, 5100, 5200, 5400 Series**

**L32, L52**  
**R53, R57**  
**S22, S32, S52**  
**W&G 504, 515**

**MX 3200, 5200**  
**LX 3200, 5200**  
**M 600, M 700**  
**BL 500, BL 600**



202570  
323-870-200  
09-009052-54

201121 A  
323-870-214  
09-009050-06 (CT)

205607 (CT)  
09-009801-41  
links/lefthand/  
à la izquierda

205890 (CT)  
09-009732-15

202571  
323-870-201  
09-009052-55

202527 (CT)  
323-870-207  
09-009070-82

277000 (CT)  
09-009846-02

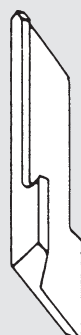
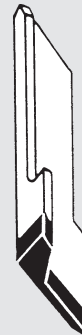
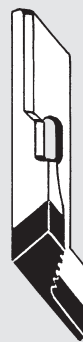
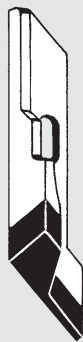

CT 210755  
91-179421-01

211771 (CT)  
09-009807-78

211662 (CT)  
09-009802-00

211662A (CT)  
09-009857-11

204835 (CT)  
09-009071-09

204152  
09-009065-29



202295  
323-870-210  
09-009-066-42

202572  
323-870-202

205609  
09-009801-40  
links/lefthand/  
à la izquierda

202893  
323-870-215  
09-009819-09 (CT)

201127  
323-870-211  
09-009054-43  
202573  
323-870-203  
09-009052-57



**DCR 601, 801, 901, 905**  
**E22, E22L, E32, E32L, E51, E52, E52L, E54, E256**  
**ETS32, ETS32L, ETS51, ETS52**  
**EX/EXT 3200, 5100, 5200, 5400 Series**

**L32, L52**  
**R53, R57**  
**S22, S32, S52**  
**W&G 504, 515**

**MX 3200, 5200**  
**LX 3200, 5200**  
**M 600, M 700**  
**BL 500, BL 600**



204161  
323-870-213  
09-009053-33



204351  
323-870-218  
09-009606-90 (CT)



204161 A  
09-009831-32



210762  
09-009620-39



277009  
09-009846-08



208393  
09-009842-89



213108  
09-009812-97



211742  
09-009825-62



211788  
09-009806-67



202874 (1)  
323-810-211  
09-009053-31



204062 (2)  
323-810-218  
09-009054-19

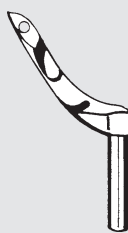

202828 (4)  
323-810-224  
09-009065-90



204663 (7)  
323-810-008  
09-009068-07



204990 (12)  
323-810-231  
09-009603-48



204702 (4)  
323-810-009  
09-009067-70



**DCR 601, 801, 901, 905**  
**E22, E22L, E32, E32L, E51, E52, E52L, E54, E256**  
**ETS32, ETS32L, ETS51, ETS52**  
**EX/EXT 3200, 5100, 5200, 5400 Series**

**L32, L52**  
**R53, R57**  
**S22, S32, S52**  
**W&G 504, 515**

**MX 3200, 5200**  
**LX 3200, 5200**  
**M 600, M 700**  
**BL 500, BL 600**

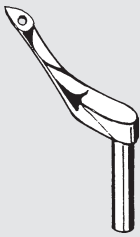

204703 (6)  
323-810-010  
09-009067-68



204704 (3)  
323-810-011  
09-009068-98



204705 (5)  
323-810-012  
09-009067-69

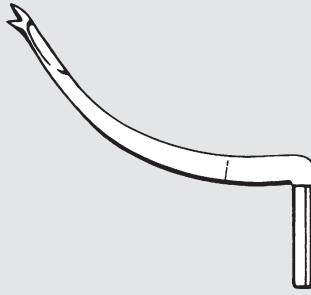

201234 A  
323-810-003  
09-009050-62

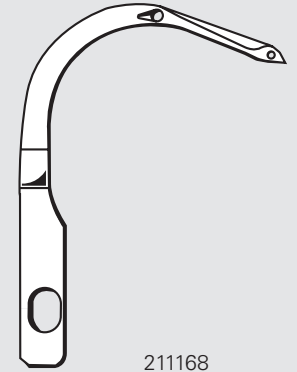

211168

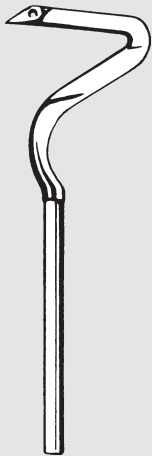

201085 B  
323-810-002  
09-009049-56

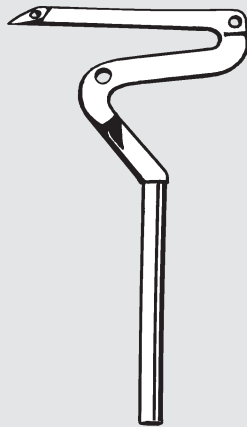

202703  
09-009065-89

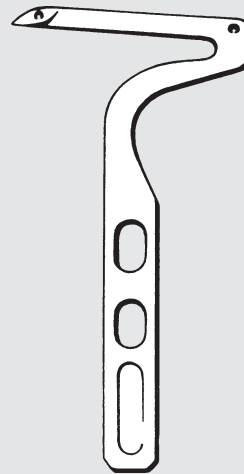

204072  
323-810-216  
09-009054-20

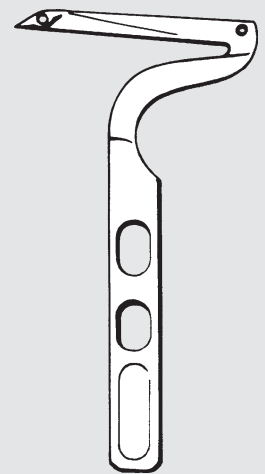

204991  
323-810-232  
09-009603-49

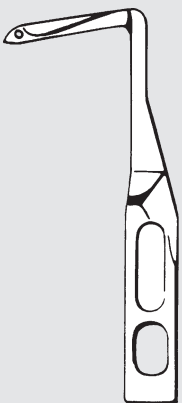

204431  
323-810-219  
09-009065-26

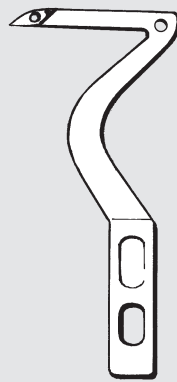

210354  
323-810-018  
09-009618-12

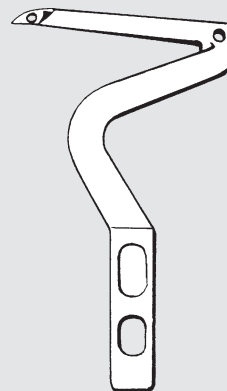

210356  
323-810-019  
09-009615-99

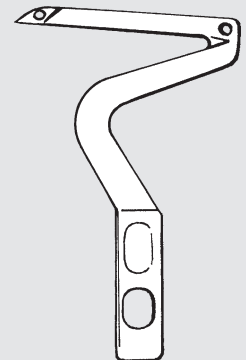

211651  
09-009802-29



**DCR 601, 801, 901, 905**  
**E22, E22L, E32, E32L, E51, E52, E52L, E54, E256**  
**ETS32, ETS32L, ETS51, ETS52**  
**EX/EXT 3200, 5100, 5200, 5400 Series**

**L32, L52**  
**R53, R57**  
**S22, S32, S52**  
**W&G 504, 515**

**MX 3200, 5200**  
**LX 3200, 5200**  
**M 600, M 700**  
**BL 500, BL 600**

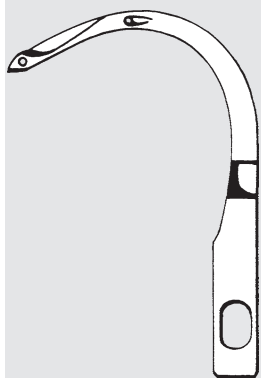

210357  
09-009807-47

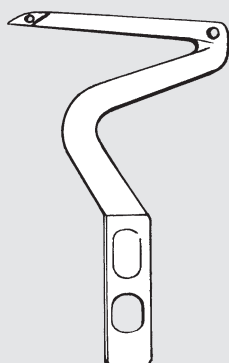

212215  
09-009802-28

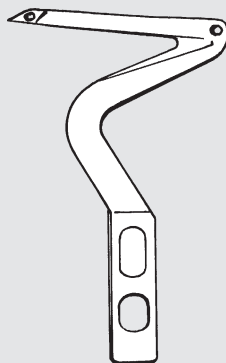

212644  
09-009804-51

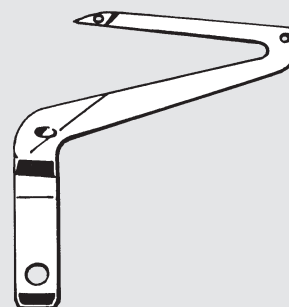

213105  
09-009812-96

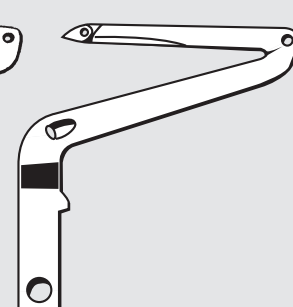

277021



210358 (2)  
323-810-021  
09-009620-31



210359 (4)  
323-810-022  
09-009616-01



210360 (6)  
323-810-023  
09-009618-08



210364 (22)  
323-810-025  
09-009616-03



210365 (24)  
323-810-026  
09-009616-04



210366 (26)  
323-810-027  
09-009620-33



210367 (28)  
09-009620-34



210729 (30)  
323-810-031  
09-009617-97



210730 (32)  
09-009617-98



211719 (38)  
09-009733-31



210512 (21)  
09-009617-06

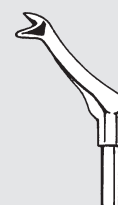

210513 (23)  
09-009617-07

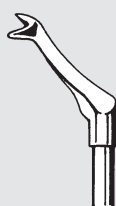

211845 (29)  
09-009733-37



212092 (10)  
09-009811-92



204949 (11)  
09-009833-45



204963 (8)  
09-009611-28



204964 (9)  
09-009611-29



**DCR 601, 801, 901, 905**  
**E22, E22L, E32, E32L, E51, E52, E52L, E54, E256**  
**ETS32, ETS32L, ETS51, ETS52**  
**EX/EXT 3200, 5100, 5200, 5400 Series**

**L32, L52**  
**R53, R57**  
**S22, S32, S52**  
**W&G 504, 515**

**MX 3200, 5200**  
**LX 3200, 5200**  
**M 600, M 700**  
**BL 500, BL 600**

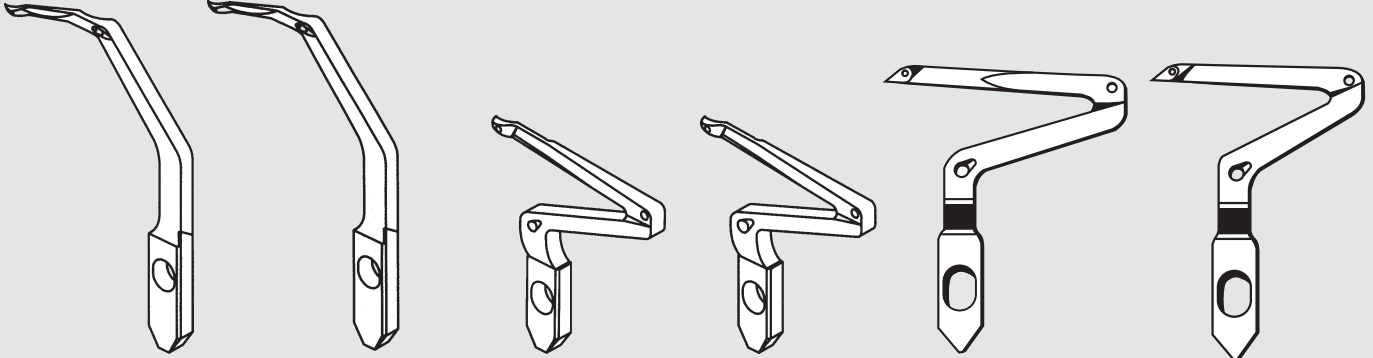

277018  
09-009846-18

277018 C  
09-009846-19

277015  
09-009846-14

277015 A  
09-009846-15

277016 A

277034

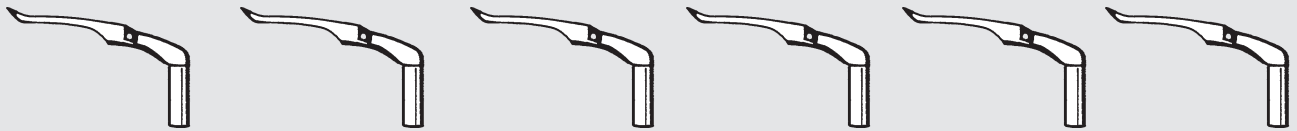

277010 (2)  
09-009846-09

277010 A (5)  
09-009846-10

277010 B

277011 (3)  
09-009846-11

277012

277013



277014 (1)  
09-009846-12

277014 A (8)  
09-009846-13

277014 B (9)  
09-009844-22

277017 (11)  
09-009846-17

277019 (12)  
09-009846-20

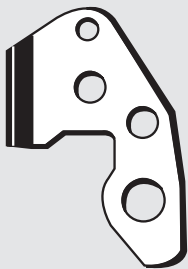

308030 (CT)

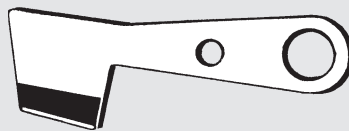

301008  
09-009621-65 (CT)

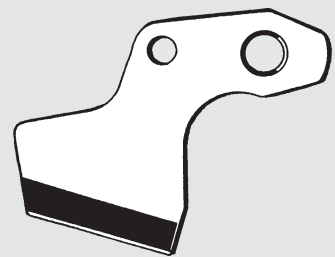

301036  
09-009806-73 (CT)

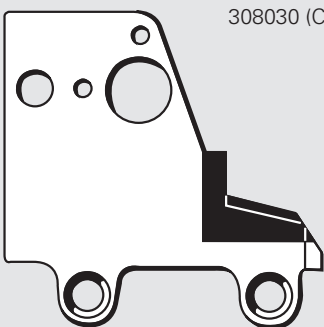

308026-91 (CT)

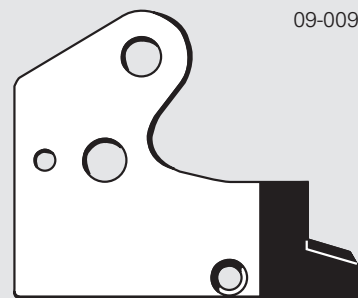

179458-05 (CT)



DCR 601, 801, 901, 905  
E22, E22L, E32, E32L, E51, E52, E52L, E54, E256  
ETS32, ETS32L, ETS51, ETS52  
EX/EXT 3200, 5100, 5200, 5400 Series

L32, L52  
R53, R57  
S22, S32, S52  
W&G 504, 515

MX 3200, 5200  
LX 3200, 5200  
M 600, M 700  
BL 500, BL 600

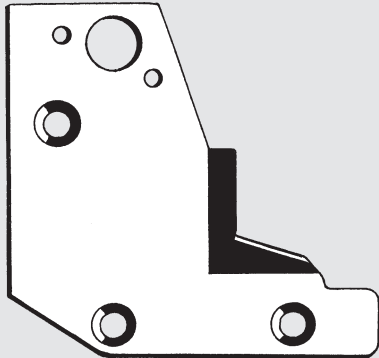

301035  
09-009806-72 (CT)



179459-05 (CT)

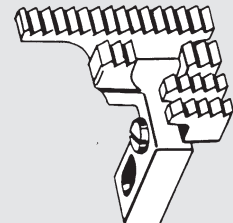

208063  
09-009071-19

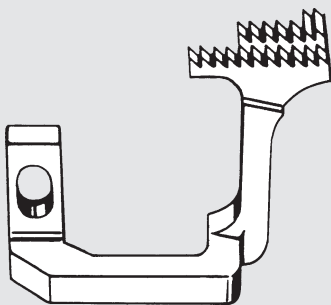

204907  
09-009068-97

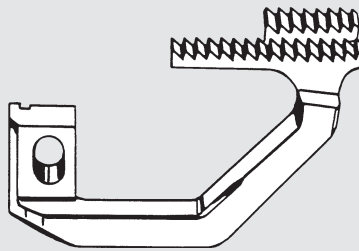

210494  
09-009616-98

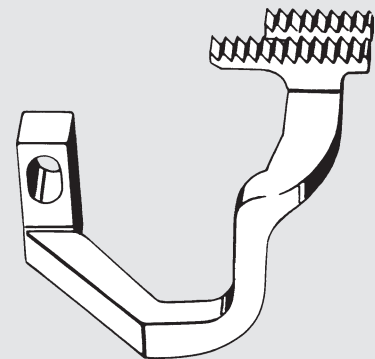

208215  
09-009071-27



208338  
09-009611-70

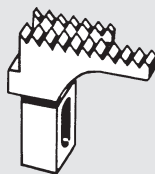

208336  
09-009611-68

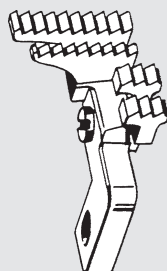

210568  
09-009617-26

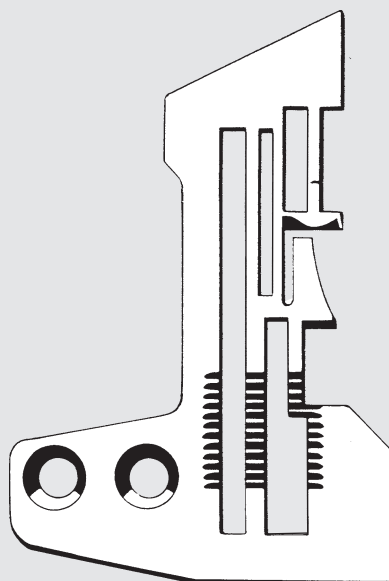

210787  
09-009620-45



DCR 601, 801, 901, 905  
E22, E22L, E32, E32L, E51, E52, E52L, E54, E256  
ETS32, ETS32L, ETS51, ETS52  
EX/EXT 3200, 5100, 5200, 5400 Series

L32, L52  
R53, R57  
S22, S32, S52  
W&G 504, 515

MX 3200, 5200  
LX 3200, 5200  
M 600, M 700  
BL 500, BL 600

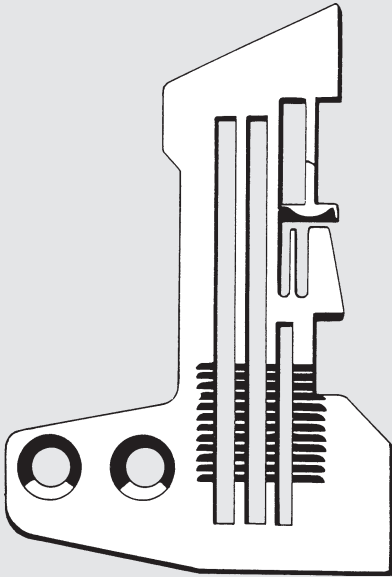

210810  
09-009620-66

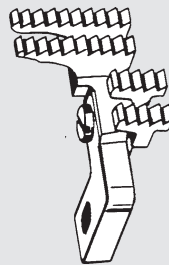

210575  
09-009617-33

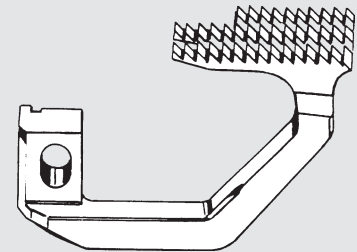

210445  
09-009616-58

TM 625

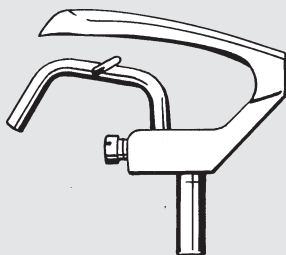

188004

M 732



209685

DCM 203, DCM 220, 230



137562  
09-009048-39





W 280-, 500-, 600-, 700-, 1500-, 2600 Series  
WT 200-, 600 Series

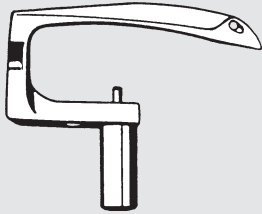

257550-91  
09-400401-00

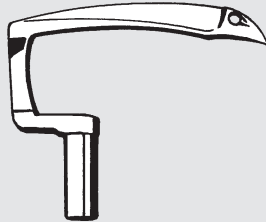

257555  
09-009854-48



350018-91  
(CT)



350024

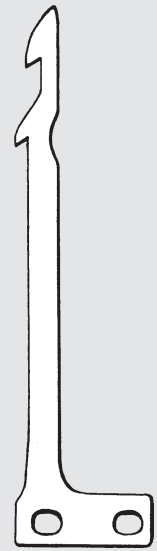

350220  
09-009825-63

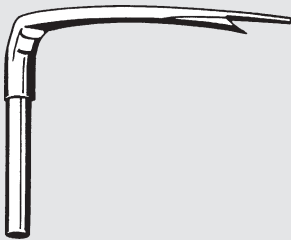

257552  
09-400404-00

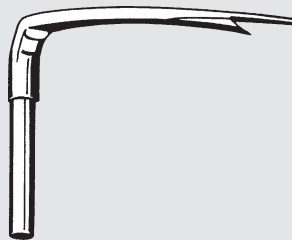

257565  
09-009826-28



257566  
09-009826-26



350218  
09-009825-64



257573 (CT)



257573 A (CT)



306394 (CT)  
09-400427-00



257574 (CT)



204161  
09-009053-33



204161 A  
09-009831-32



**FS, FV, FW Series**

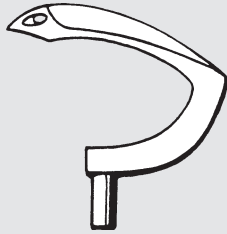

236504 A  
09-009852-28



236502 A  
09-009852-26

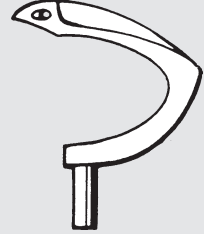

236503 A  
09-009852-27

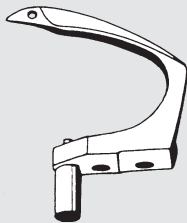

236500 A  
09-009854-55

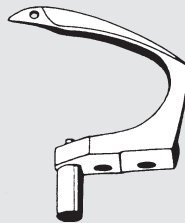

236500  
09-009854-54

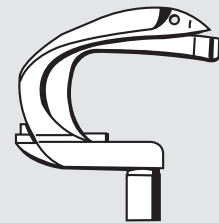

236501 A



236618



236606 SUPER  
09-009854-52



236608 SUPER  
09-009854-53



236101  
09-009854-49



## 133, 134



15323



- 15320-2,0
- 15320-2,5
- 15320-3,0
- 15320-3,5
- 15320-4,0
- 15320-4,5
- 15320-5,0
- CT 15320-3,0
- CT 15320-3,5
- CT 15320-4,0
- CT 15320-4,5
- CT 15320-5,0
- CT 15320-6,0

## 141, 143

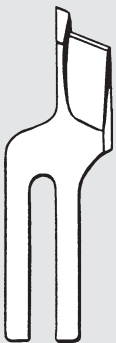

19506 x 5,0



19506 x 7,0



19506 x 9,0

## 142, 242, 244, 1242, 1243, 1244



113460



10192



91-048908-10-30

91-048909-93/001 (CT)

## 151, 153



15435 x 4,0  
15435 x 5,0



15435 x 7,0



15435 x 9,0

## 155, 175, 194, 294, 1293, 1294, 1295, 1296, 3713



19737 x 5,0



19737 x 7,0



19737 x 9,0



Ersatzteile  
aus eigener  
Herstellung

**Teile passend für  
Pfaff-Nähmaschinen**

**143, 191, 193  
471, 474, 491, 493, 571, 574, 591  
1471, 1474, 1491, 1493, 1494  
1571, 1574, 1591**

**2571, 2574, 2591  
3734-2/01, /21  
3834-4/11, /21**

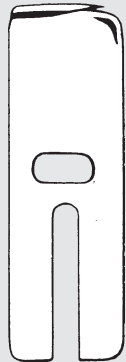

91-011165-04/001 = 2,7  
91-011165-04/002 = 3,0

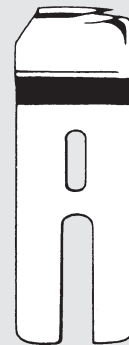

91-011233-04/011 = 2,7 (HSS)

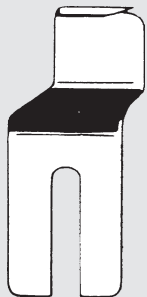

91-011179-04/001 = 2,7  
91-011179-04/003 = 3,5



91-011179-04/011 = 2,7 (HSS)



91-011324-04/001 = 2,7  
91-011324-04/003 = 3,5



91-011324-04/013 = 3,5 (HSS)



91-119202-04/001



91-119202-04/011 (HSS)



91-119444-04/001



91-119444-04/011 (HSS)

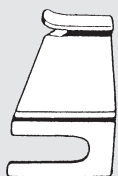

91-119714-05



91-119715-05



91-164754-05



91-175952-05  
Kl. 493-755-743-04



**143, 191, 193  
471, 474, 491, 493, 571, 574, 591  
1471, 1474, 1491, 1493, 1494  
1571, 1574, 1591**

**2571, 2574, 2591  
3734-2/01, /21  
3834-4/11, /21**

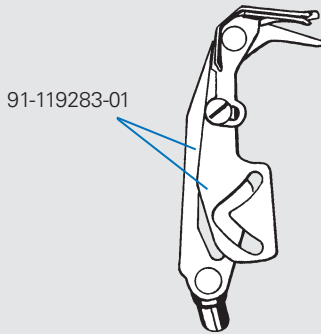

91-119283-01

91-119486-91



91-150526-04/001  
Bx5,0

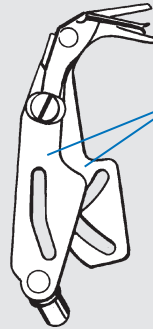

91-164673-01

91-164672-91



91-150868-24/002  
BN5

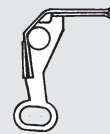

91-119455-05



91-150739-24/001  
Bx5,0

**194-900, 1293**



91-011957-15

**333, 335, 337**



91-014046-05

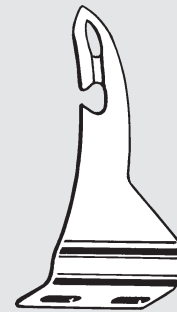

91-165505-05  
91-175540-05

**441, 442**

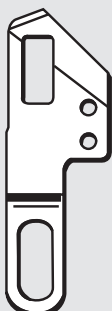

91-173197-15

**5463, 5467  
5483, 5487, 5489  
3801, 3806, 3811, 3832**



91-172358-05  
91-172071-05



91-054896-05

**540**



91-018147-05



Ersatzteile  
aus eigener  
Herstellung

**Teile passend für  
Pfaff-Nähmaschinen**

**421, 422, 441, 521, 1521, 1525, 1526  
1421, 1422, 1425, 1426, 1446  
3587, 3588, 3590  
3715**

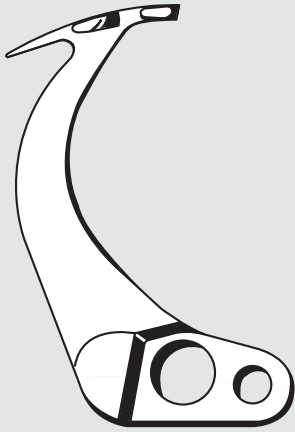

91-164925-05

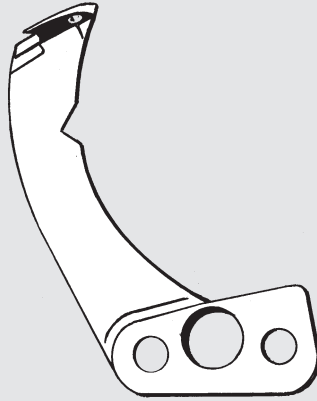

91-176357-05

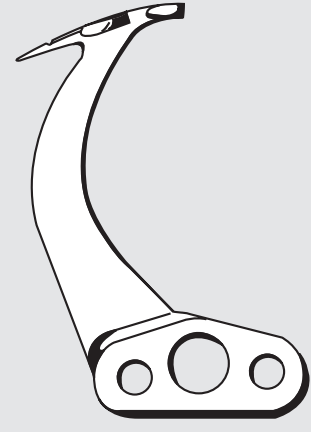

91-176094-05

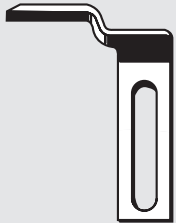

91-176098-05

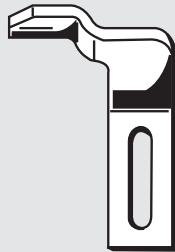

91-186659-05



91-166700-04/001 =7,0  
(HSS)



91-166700-04/002 =9,0  
(HSS)



91-166700-04/003 =12,0  
(HSS)



91-186661-05



91-166701-04/004 =7,0  
(HSS)



91-166701-04/005 =9,0  
(HSS)

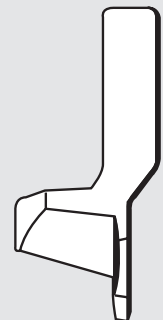

91-166701-04/006 =12,0  
(HSS)



**3548, 5642, 5645, 5646**

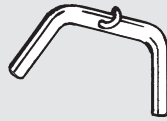

91-172802-01

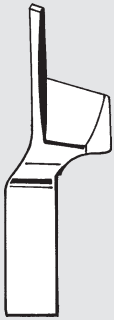

91-173792-05 x 7,0

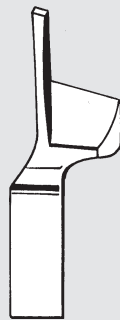

91-173792-05 x 9,0



91-178926-05

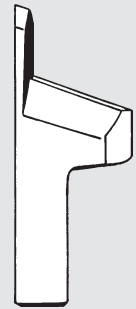

91-177919-05

**418, 437, 438, 439  
917, 918, 919, 937, 938, 939  
2438, 3568, 3704, 4238  
KSM 200  
918U, 938U, 939U**

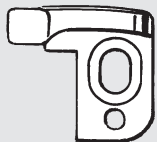

91-167973-05

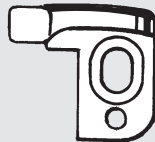

91-167350-01 (CT)



91-168498-15



91-168499-05



91-150166-05  
solid carbide  
metal solide duro

**3306, 3307, 3860**



91-132558-05



91-110482-05

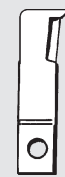

91-180295-05



Ersatzteile  
aus eigener  
Herstellung

**Teile passend für  
Pfaff-Nähmaschinen**

**461, 463, 469  
481, 483, 487, 489  
1051, 1053  
1181, 1183**

**1481, 1483, 1487, 2481, 2483  
5463, 5483, 5489  
3566, 3568, 3586, 3588  
3819, 3822, 3827**

**951, 953  
563**

**3511, 3701  
3519, 9083**



69595 x 5,0 (HSS)



69595 x 7,0 (HSS)



69595 x 9,0 (HSS)



069596 x 7,0 (CT)  
069596 x 9,0 (CT)



169395 x 5,0 (HSS)



169395 x 7,0 (HSS)



CT 169395 x 7,0



169395 x 9,0 (HSS)



CT 169395 x 9,0



91-170440-05 (HSS)



91-170560-04/002 =7,0  
(HSS)



91-170560-04/003 =9,0  
(HSS)



91-265118-05 (HSS)  
KI. 3822-1/24



91-189140-05 (HSS)



91-165629-05 (HSS)





**461, 463, 469  
481, 483, 487, 489  
1051, 1053  
1181, 1183**



91-171853-15/000

**1481, 1483, 1487, 2481, 2483  
5463, 5483, 5489  
3566, 3568, 3586, 3588  
3819, 3822, 3827**



91-264338-15



91-165642-15

**951, 953  
563**



91-169239 x 0,8

**3511, 3701  
3519, 9083**



91-169239 x 1,0

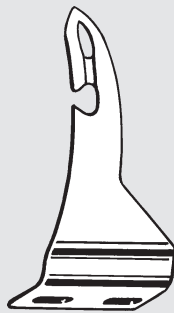

91-165505-05  
91-175540-05

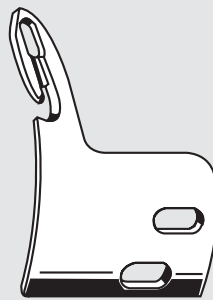

91-262184-05

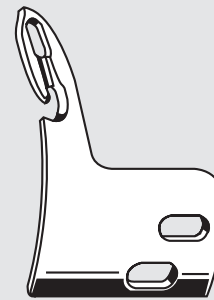

91-264240-05

**3334, 3335, 3336, 3337, 3338, 3339**



91-182344-05

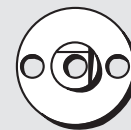

91-065546-05

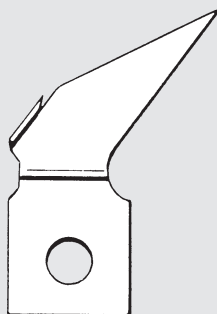

91-022096-05  
91-132168-05



91-130182-05

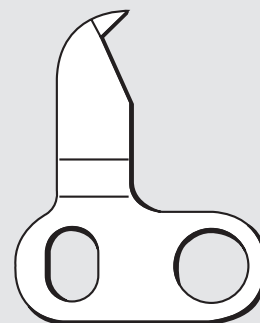

91-130183-05



Ersatzteile  
aus eigener  
Herstellung

Teile passend für  
Pfaff-Nähmaschinen

1114



J101.10.1-2



J101.10.1-7

1163, 9063

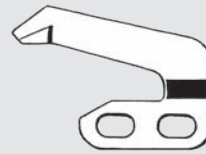

JGR1046-8

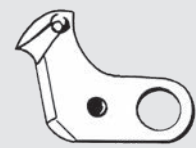

JGR1049/2-8

1122

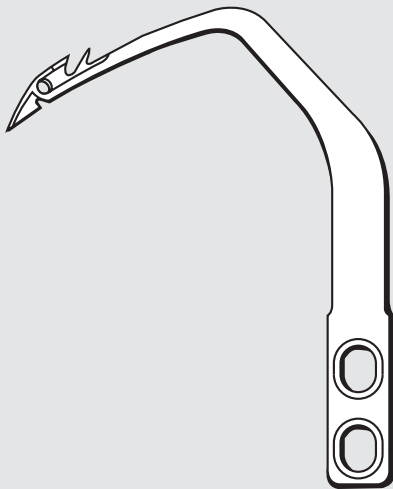

J211.7.7



J211-0060

3371



J501GB107

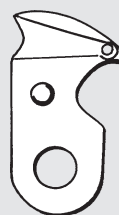

J501BJ133

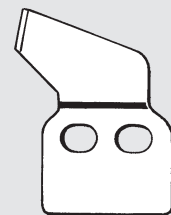

91-181729-05  
J501GB160



5704, 5714, 5716, 5742  
= Pegasus



J202527 A



J204161



J208393



J204062

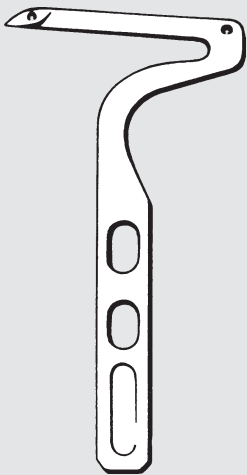

J204072

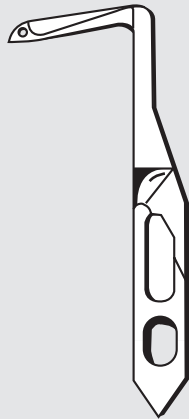

J209685



J204702



J204949

3519

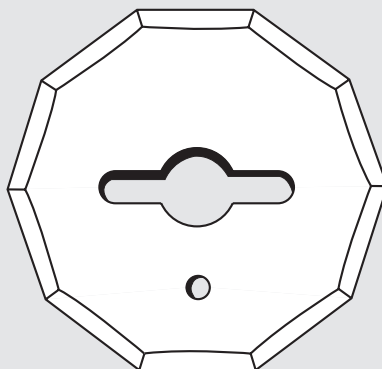

- 99-134505-05
- 99-134505-05 (HSS)
- 99-134505-05 (TIN)



Ersatzteile  
aus eigener  
Herstellung

Teile passend für  
Pfaff-Nähmaschinen

3114, 3116, 3117, 3119, 3527

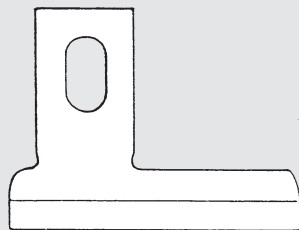
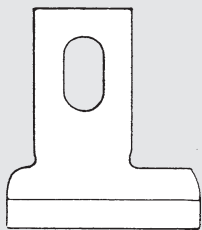
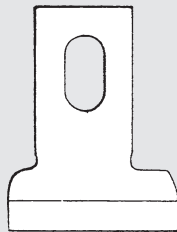
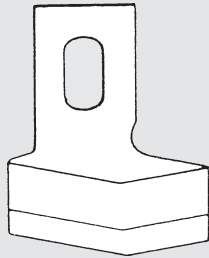
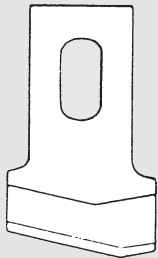
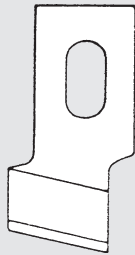
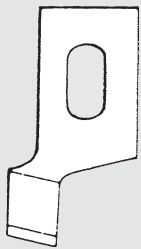

HSS = High speed steel  
Acero rápido de  
alto redimiento

91-020241 - 6,4	91-020241 - 22,2
91-020241 - 9,5	91-020241 - 25,4
91-020241 - 11,0	91-020241 - 28,6
91-020241 - 12,7	91-020241 - 31,7
91-020241 - 14,0	91-020241 - 33,3
91-020241 - 16,0	91-020241 - 36,5
91-020241 - 17,5	91-020241 - 38,1
91-020241 - 19,0	91-020241 - 39,7
91-020241 - 20,0	

91-120748 - 6,4	= 71-90 1/4
91-120748 - 9,5	= 71-90 3/8
91-120748 - 11,0	= 71-90 7/16
91-120748 - 12,7	= 71-90 1/2
91-120748 - 14,0	= 71-90 9/16
91-120748 - 16,0	= 71-90 5/8
91-120748 - 17,5	= 71-90 11/16
91-120748 - 19,0	= 71-90 3/4
91-120748 - 22,2	= 71-90 7/8
91-120748 - 25,4	= 71-90 1
91-120748 - 28,6	= 71-90 1 1/8

4644, 4661

siehe Pegasus W 664  
see Pegasus W664  
véase Pegasus W 664



**S 2, S 200, S 2000  
S 4000, S 5000**



S 2-51 N  
20-0051-1-024  
left



S 2-51 R  
20-0051-1-024  
center



S 2-51 M  
20-0051-1-024  
right

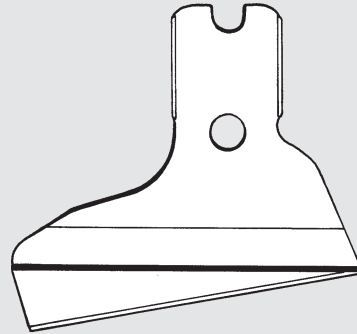

20-0356-0-003 ED

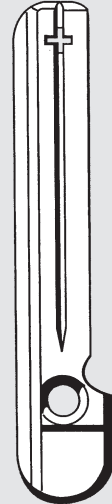

20-0051-0-003



20-0119-2-000  
20-0112-0-000  
S 119-N



20-0116-3-000  
20-0111-0-000  
S 116-N 2



20-0094-1-000



20-0094-0-000

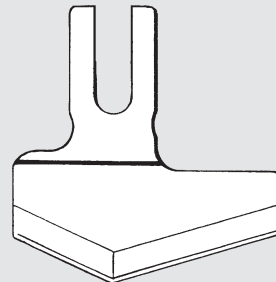
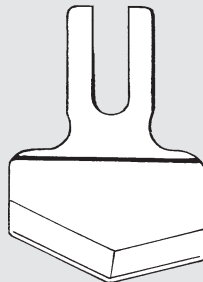
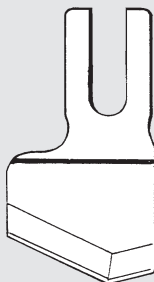
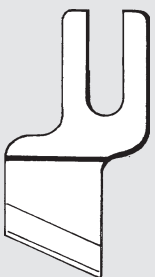

- 23-2356-2-049 1/4
- 23-2356-2-050 3/8
- 23-2356-2-051 7/16
- 23-2356-2-052 1/2
- 23-2356-2-053 9/16
- 23-2356-2-054 5/8
- 23-2356-2-055 3/4
- 23-2356-2-056 7/8
- 23-2356-2-057 1
- 23-2356-2-058 1 1/8
- 23-2356-2-059 1 1/4
- 23-2356-2-060 1 3/8
- 23-2356-2-999 1 1/2



**S 101, 104**

Looper set USA: 03-5250-0-000



14-4004-0-000  
10-4004 USA  
14-4005-0-000  
10-4005 USA  
0,5 mm  
14-4005-0-030  
0,8 mm

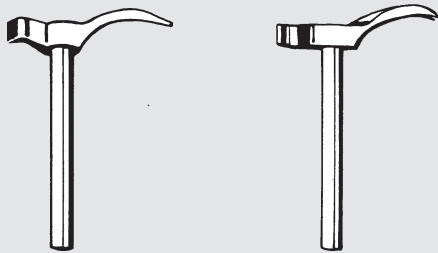

14-4008-1-000  
10-4008 USA  
14-4009-1-000  
10-4009 USA

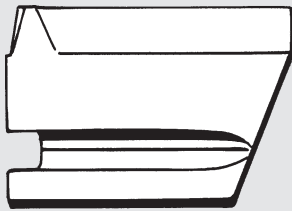

Block/Steel Type A-69-R  
10-1069-0-001 1/2 - 13  
10-1069-0-002 5/8 - 16  
10-1069-0-003 3/4 - 19  
10-1069-0-004 7/8 - 22  
10-1069-0-005 1 - 25  
10-1069-0-006 1 1/8 - 29  
10-1069-0-007 1 1/4 - 32  
10-1069-0-009 1 1/2 - 38

Greifer deutsche Ausführung:  
Looper German execution:  
Ancoras modelo alemán:

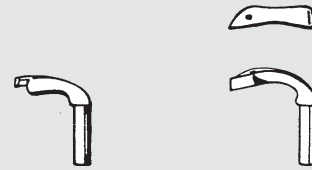

10-4004  
= 14-4004-0-000  
10-4005

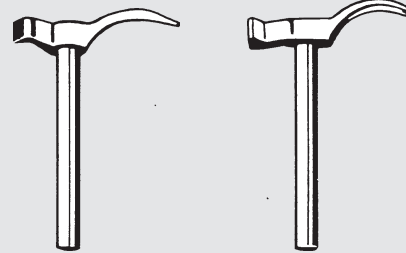

10-4008  
= 14-4008-1-000  
10-4009



10-4006-0-000



10-4007-0-000

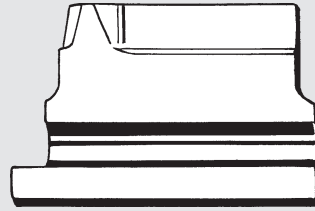

Block/Steel Type A-69-B  
10-1069-0-073 1/2 - 13  
10-1069-0-074 5/8 - 16  
10-1069-0-076 7/8 - 22  
10-1069-0-077 1 - 25  
10-1069-0-079 1 1/4 - 32  
10-1069-0-080 1 3/8 - 35  
10-1069-0-081 1 1/2 - 38

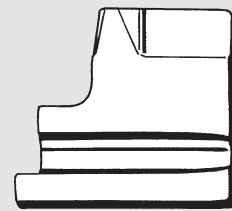

Block/Steel Cord Trim  
10-1069-0-020 5/8 - 16  
10-1069-0-021 3/4 - 19  
10-1069-0-022 7/8 - 22



14-1197-1-000



10-3072-0-024 1 1/4 C72-RJRE  
10-3072-0-059 5/8 CTRE  
10-3072-0-060 3/4 CTRE  
10-3072-0-067 5/8 CTLE  
10-3072-0-023 1 1/4 NE (ohne Auge/without eye)



10-3072-0-014

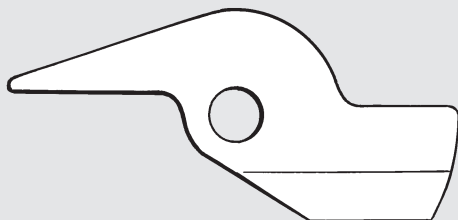

10-2206-1-000

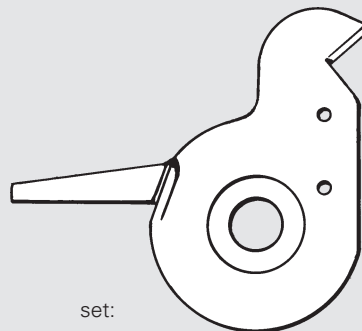

set:  
03-5238-0-00

10-2207-1-000

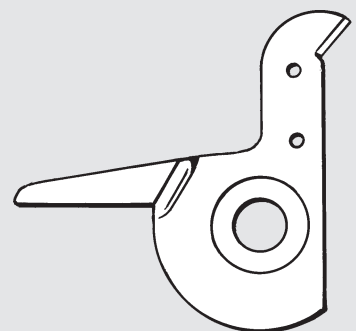

10-2207-1-600



**S 100 (Global BH 770), S 111  
S 211, S 311 XL 21**



17-0069-4-048  
Global:  
522-080-694048



17-0069-4-049  
Global:  
522-080-694049



17-0069-4-019

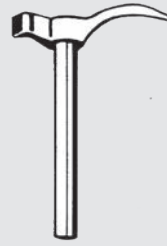

17-0004-9-894  
Global:  
522-980-049894

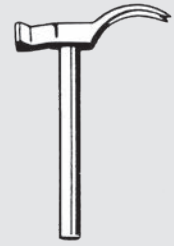

17-0004-9-895  
Global:  
522-980-049895

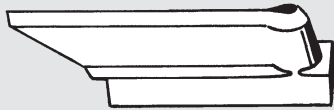

17-0064-5-864 (CA)  
Global:  
522-080-645864

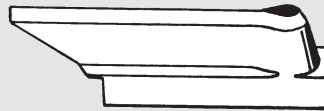

17-0064-5-950 (CB)  
Global:  
522-080-645950



17-0087-0-204

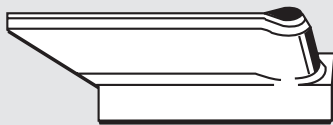

19-0087-0-434



17-0064-5-849 16 mm  
17-0064-5-852 22 mm  
17-0064-5-854 26 mm  
17-0064-5-855 28 mm  
17-0064-5-856 32 mm  
17-0064-5-858 38 mm

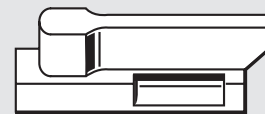

19-0064-5-855



**31, 32, 36, 38, 42, 46, 47, 48**  
**Lockwelt 2000, 3000, 6000, 7000**

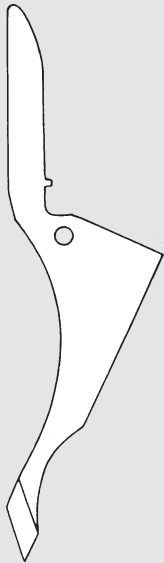

40-0012-2-045 (HSS)  
P 12 XN 1  
Kl. 42

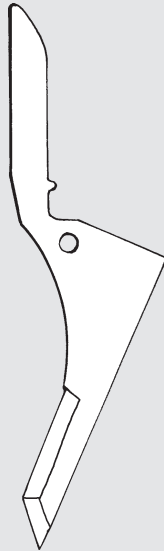

42-0012-0-000 (HSS)  
P 12 XN 1-SP  
Kl. 42



40-0127-2-000  
P 127  
40-0127-0-001 (TIN)

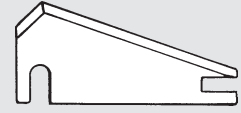

46-1001-4-136  
P 127 Special  
0,6 mm HSS

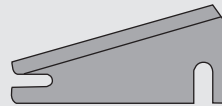

46-1001-5-487  
Ceramic  
Kl. 36, 38, 46, 47

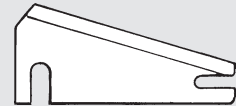

46-1004-9-073  
Kl. 36, 38, 46, 47



32-2019-1-000  
Kl. S32



46-1125-5-000  
Kl. 36, S46, 47



46-1001-5-289



40-0057-6-000



40-0058-5-000



48-1125-5-594 (CT)  
Kl. 38, 46, 47, 48





46-1125-5-581  
Kl. 38



48-1125-5-721  
Kl. 48

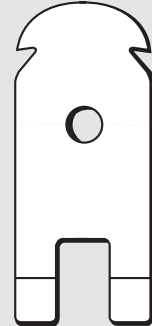

68-0050-0-012

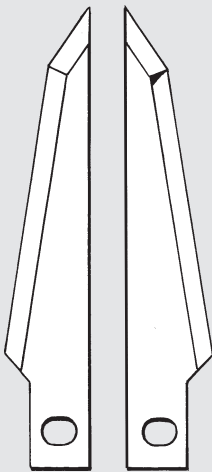

32-2047-1-001 32-2047-1-002  
67-2047-1-001 67-2047-1-002  
32-2047-1-050  
Kl. S 32

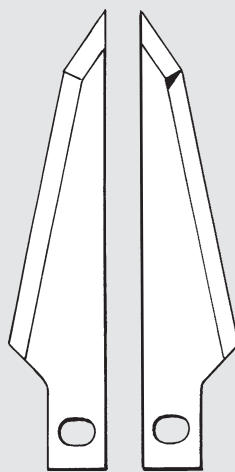

32-2048-1-001 32-2048-1-002  
67-2048-1-001 67-2048-1-002  
32-2048-1-050  
Kl. S 32

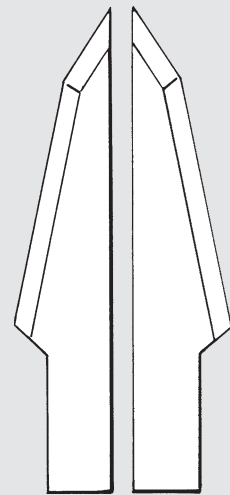

68-0052-0-012



**27, 28, 29, 227, 228, 229, 327, 328, 329, 527, 529  
627, 629, 637, 639, Orion  
Omnitex  
Vega**



202142-0-10  
209348-0-10  
270-112



207000-2-00 (CT)  
209347-0-00 (CT)



203066-0-10  
279-112



207006-2-00 (CT)



202145-0-10  
270-113



207011-0-00



202146-0-11  
270-113/1



207015-2-00 (CT)



207017-2-00 (CT)



209593-0-00



203010-0-10  
209358-0-10  
277-112



207002-2-00 (CT)  
209357-2-00 (CT)



920780-0-10



**27, 28, 29, 227, 228, 229, 327, 328, 329, 527, 529**  
**627, 629, 637, 639, Orion**  
**Omnitex**  
**Vega**



207001-2-00 (CT)  
209355-2-00 (CT)



203012-0-10  
277-113  
2777-113



207016-2-00 (CT)

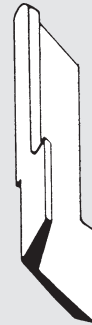

203783-0-10  
209352-0-10  
2777-1121

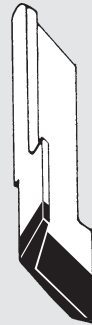

207003-2-00 (CT)  
209351-2-00 (CT)

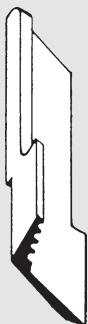

203759-0-10  
209354-0-10  
2777-112

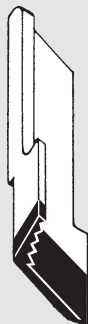

207004-2-00 (CT)  
209353-2-00 (CT)



209341-0-10



209342-2-10 (CT)



209340-2-10 (CT)



209425-2-01 (CT)



204693-0-11  
290-113 SP (1 mm)



207020-2-01 (CT)



204693-0-11 BAK  
Ceramic



205151-0-00



27, 28, 29, 227, 228, 229, 327, 328, 329, 527, 529  
627, 629, 637, 639, Orion  
Omnitex  
Vega



211424-2-00 (CT)



208011-0-01



204021-0-10  
27.277-074  
großes Öhr  
large eye  
Agujero grande



204033-0-10  
27.277-0745  
kleines Öhr  
small eye  
Agujero pequeño



204022-0-10



202092-0-11  
270-D-074-1

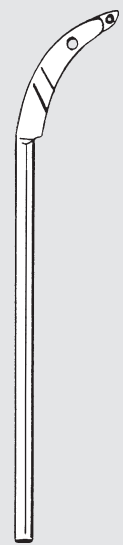

206512-0-02

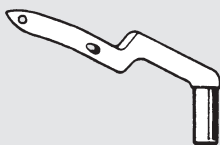

209223-0-00  
großes Öhr  
large eye  
Agujero grande

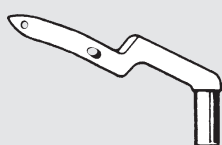

209248-0-00  
kleines Öhr  
small eye  
Agujero pequeño

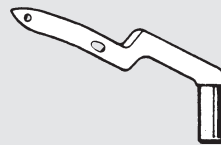

209249-0-00  
kleines Öhr  
small eye  
Agujero pequeño

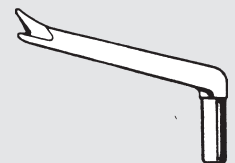

209247-0-00



27, 28, 29, 227, 228, 229, 327, 328, 329, 527, 529  
627, 629, 637, 639, Orion  
Omnitex, Vega

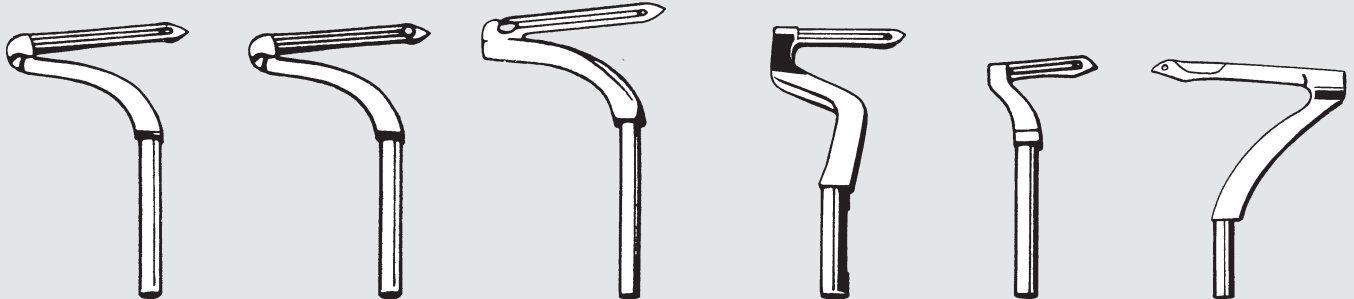

202094-0-13  
270-075  
kleines Öhr  
small eye  
Agujero pequeño

202095-0-13  
270-075/2  
großes Öhr  
large eye  
Agujero grande

202413-0-13  
270-075/1

207722-0-01

204676-0-11  
290-075/2

206048-0-13

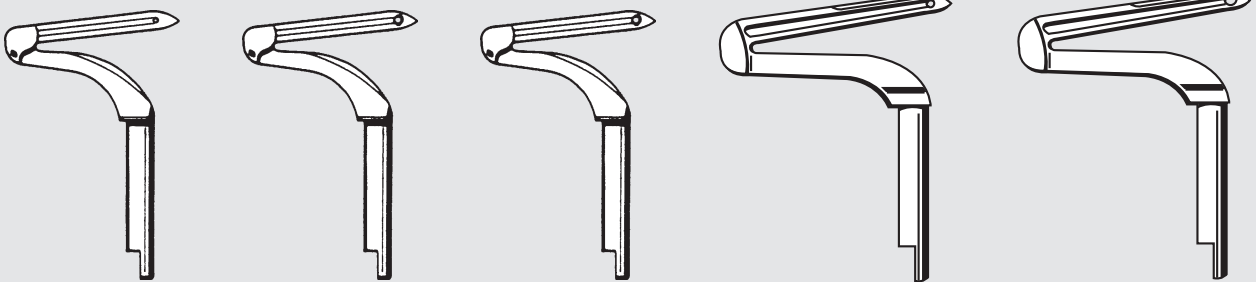

209264-0-00  
kleines Öhr  
small eye  
Agujero pequeño

209265-0-00  
großes Öhr  
large eye  
Agujero grande

209267-0-00

211266-0-00  
kleines Öhr  
small eye  
Agujero pequeño

211267-0-00  
großes Öhr  
large eye  
Agujero grande

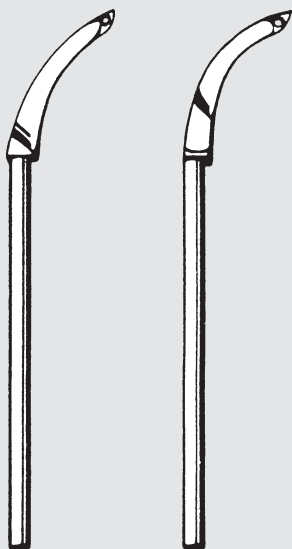

203005-0-10  
277-074

203755-0-10  
207208-0-00  
2777-074



209261-0-00



211248-0-00  
kleines Öhr  
small eye  
Agujero pequeño



211249-0-00  
großes Öhr  
large eye  
Agujero grande



207995-0-00



27, 28, 29, 227, 228, 229, 327, 328, 329, 527, 529  
627, 629, 637, 639, Orion  
Omnitex

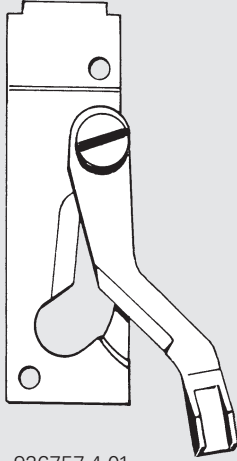

926757-4-01



926753-2-01 (CT)



926756-2-01 (CT)



926758-0-01



923918-0-01



923919-0-01

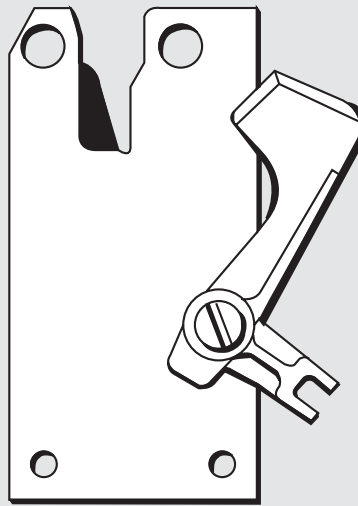

928533-4-01

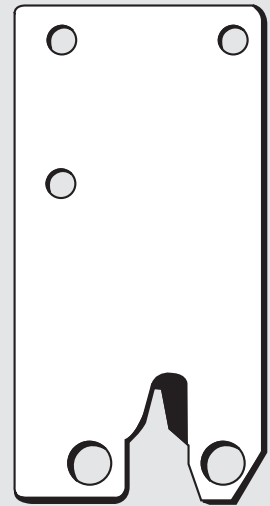

928531-2-00 (CT)



926752-4-00



27, 28, 29, 227, 228, 229, 327, 328, 329, 527, 529  
627, 629, 637, 639, Orion  
Omnitex

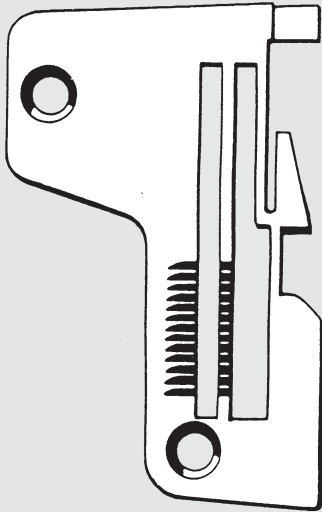

202148-0-10  
270-114

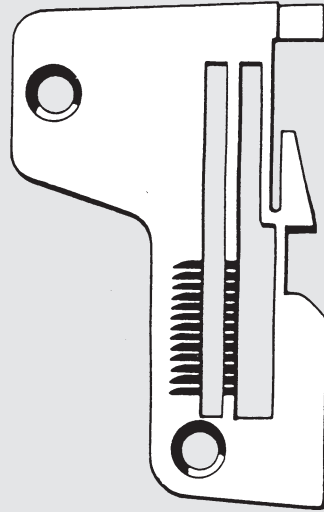

202504-0-10  
270-1141

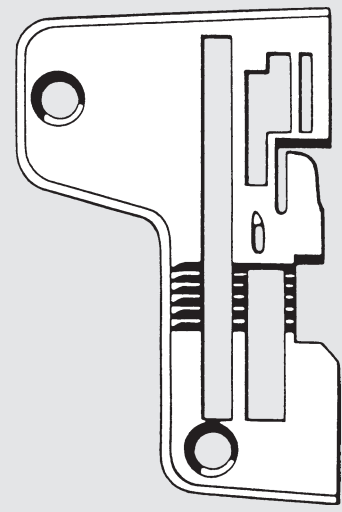

204809-0-00

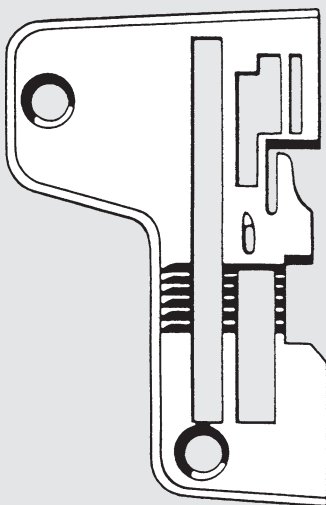

204695-0-11  
290-114/1



**21 und 24 Stella  
25 und 26 Stella**



200271-0-10  
1112  
CT 200271-0-10



200274-0-10  
1113  
CT 200274-0-10



200403-0-10  
2112



CT 200404-0-10

**427, 429**

siehe/see/véase  
Siruba

**63, 64, 65, 155, 261, 262, 263, 264 Sirio  
73  
91, 93, 94 MIZAR**

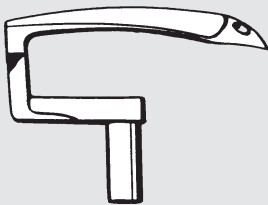

302057-0-13  
633-075/2

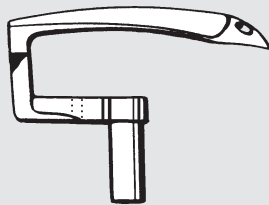

312057-0-00

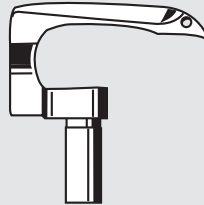

303419-0-12



302808-0-10  
63.78-113



315507-0-00

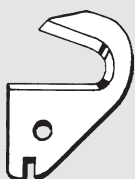

303012-0-10



302807-0-10  
63.78-112





63, 64, 65, 155, 261, 262, 263, 264 Sirio  
73  
91, 93, 94 MIZAR



318735-0-00



318792-2-00 (CT)



318791-2-00 (CT)

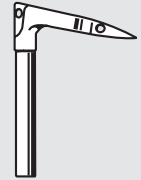

101572-0-12



318794-2-00 (CT)

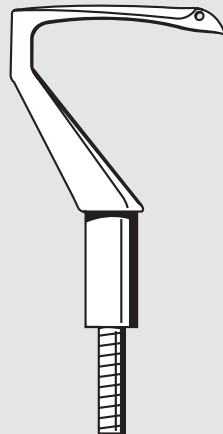

315863-2-02

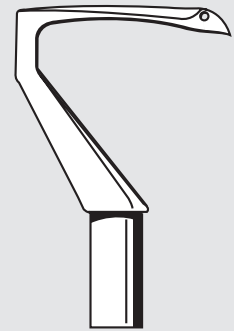

321128-0-10  
F 63-45-3 MD-05

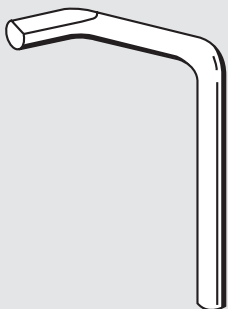

315805-0-00

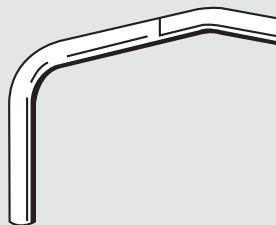

308142-0-00

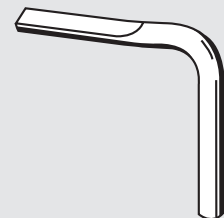

321164-0-00



63, 64, 65, 155, 261, 262, 263, 264 Sirio  
73  
91, 93, 94 MIZAR

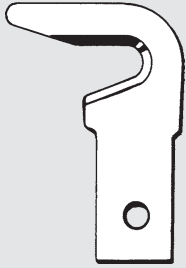

306224-0-10

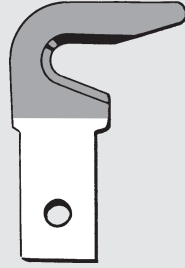

306286-2-00 (CT)

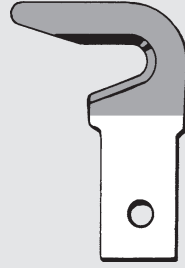

306285-2-00 (CT)



306284-2-00 (CT)



306283-2-00 (CT)

171, 177



924670-0-20



924638-0-10



944422-0-00



933201-0-00



933186-0-00



**183 - 00 - 4 MR 04 - 6,0 mm**



350453-0-00



350452-0-00

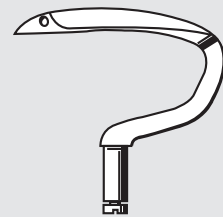

350145-2-11

**183 - 00 - 4 MR 01 - 5,6 mm**



350069-0-00



350183-0-00



350107-0-00

**184**

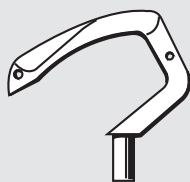

351161-0-10

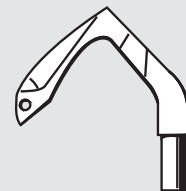

351163-0-10



**14 U**

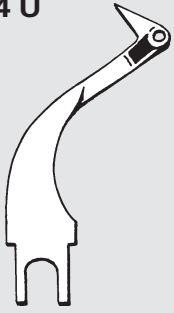

410262

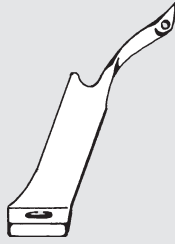

410434

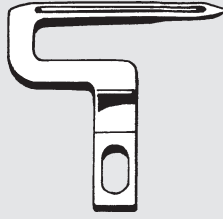

410452

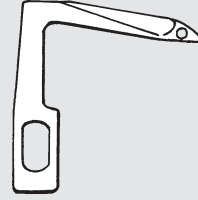

412553

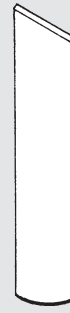

410295



412585

**47 W, 51 W, 52 W, 52 K  
104 W, 110 W, 136 W, 236 G, 236 U, 236 W**

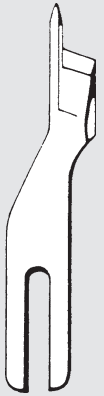

241574 (HSS)



238548

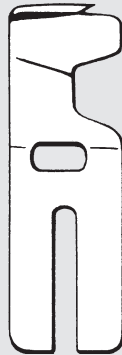

233934

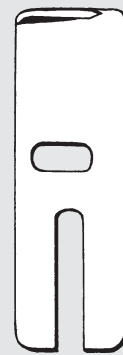

238508

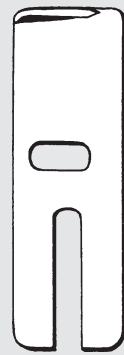

238508 (HSS)

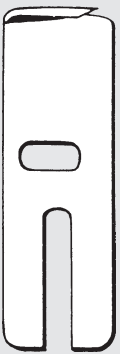

238543



238546



8061 A-3,1

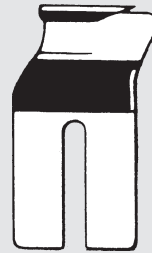

249191-3,1

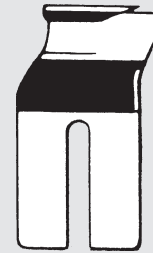

249191 (HSS)



263735

**261-U**

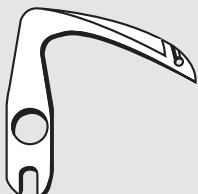

32820

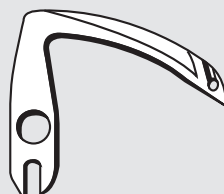

32823

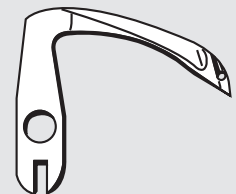

32824



71-1, 3, 5, 6, 11, 12, 13, 30, 31, 32, 34, 35, 40, 42, 45, 101, 107  
271-K 11, -K 13  
371, 471, 1371 A

HSS = High speed steel  
Acero rápido de  
alto rendimiento

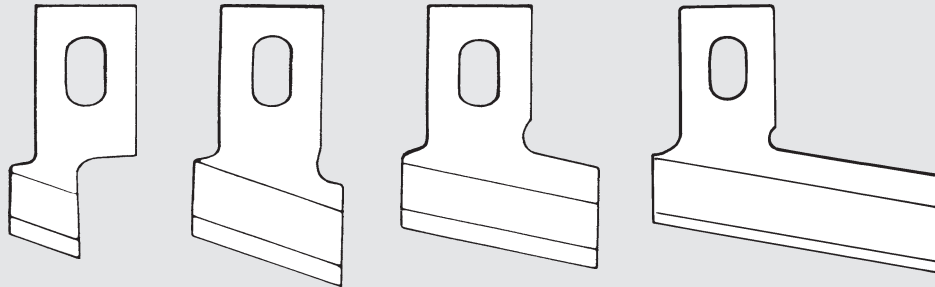

23443 - 23459:

71 1/8	71 13/16
71 1/4	71 7/8
71 5/16	71 15/16
71 3/8	71 1
71 7/16	71 1 1/16
71 1/2	71 1 1/8
71 9/16	71 1 3/16
71 5/8	71 1 1/4
71 11/16	71 1 3/8
71 3/4	71 1 1/2

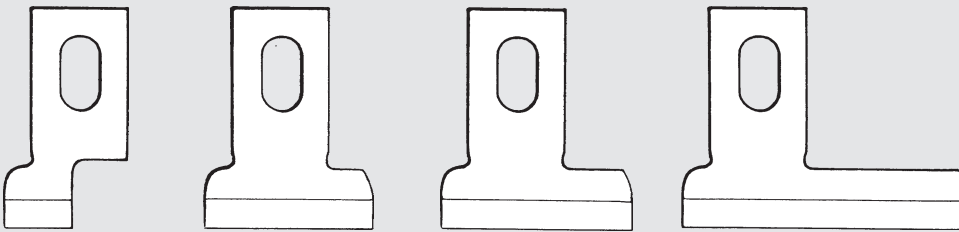

71-90 1/8	71-90 11/16
71-90 1/4	71-90 3/4
71-90 5/16	71-90 13/16
71-90 3/8	71-90 7/8
71-90 7/16	71-90 15/16
71-90 1/2	71-90 1
71-90 9/16	71-90 1 1/8
71-90 5/8	71-90 1 1/4

81



42305  
CT 42305



42309  
CT 42309

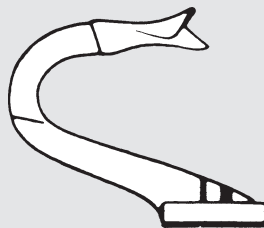

42072

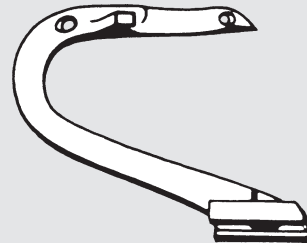

42220

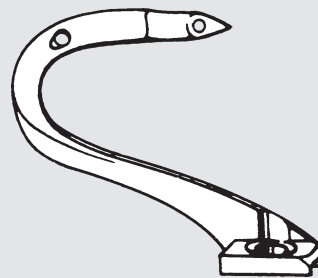

42239

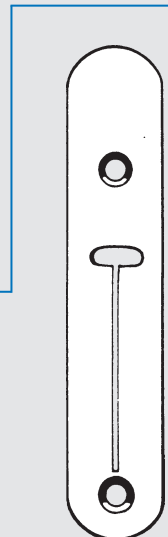

71, 271 K



40048  
Kl. 71-30



39609  
Kl. 71-30



39867  
Kl. 71-48/71-112

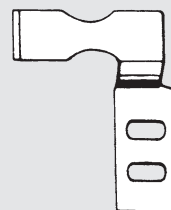

40035  
271926

39608  
Kl. 71-30



**96, 451 K 11  
245, 251**



147211  
276489 (CT)



5730, 142032, 52131  
5730 3/32

**175, 375  
Consew 260, 261**



175085

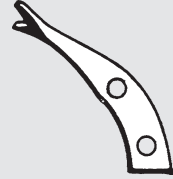

175547

**246 K, 460, 990**



164308



CT 164308



164550



164026



CT 164026



164556



CT 164556



82264



CT 82264



107797



164037



164728  
164233  
164552



164809 (CT)



164813 (CT)



246 K, 460, 990



164045



164252



164375



164619

68, 69, 269 W, 270

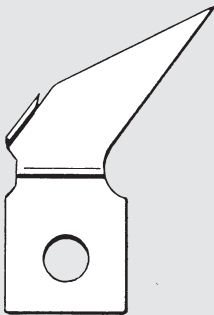

55459



55458



239372



239367

281



785780-001



299 U

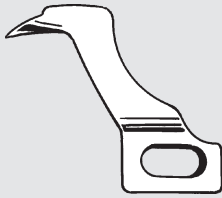

548231

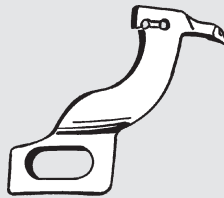

548232

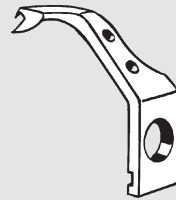

548207

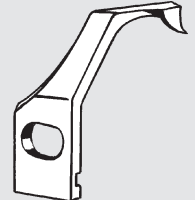

548205

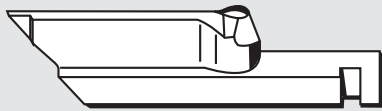

544599

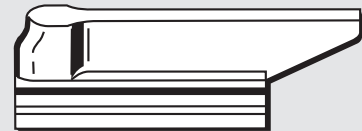

548762 1/2"

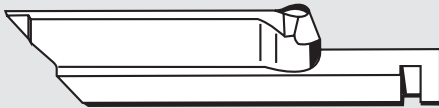

548886

548763 5/8"

548764 3/4"

548765 7/8"

548766 1"

548767 1 1/8"

548768 1 1/4"

548769 1 3/8"

548770 1 1/2"

548771 1 5/8"

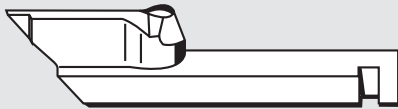

548935

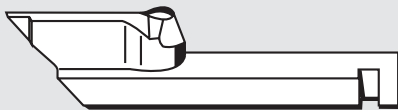

548936

300 U, 300 W, 302 U, 320 W

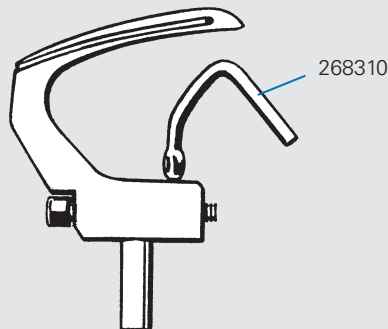

268382  
281208

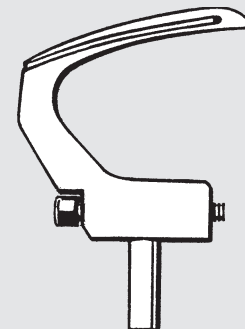

268380





369

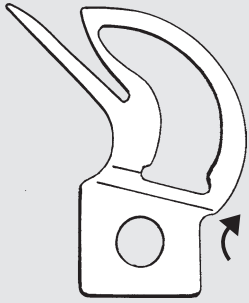

239715

375 B

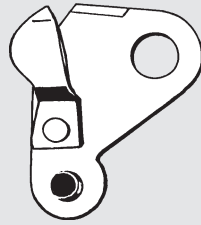

373537



373539

400 W 11

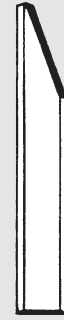

270616



270619

491 D, 591 D, 591 E, 601 D

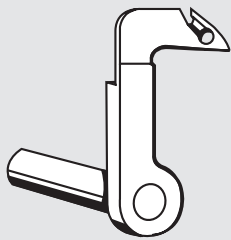

414030



414029



540741

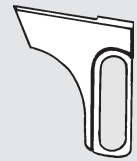

540760

660 AX 2

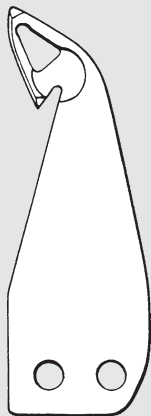

GU 3605  
Pescke Nr. 19



GU 3606  
Pescke Nr. 18

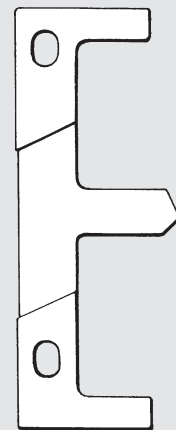

107519



**1831 U, 1832 U, 1842 U  
(= Kingtex SH 6000)**



377462 (CT)  
6031314 C 500

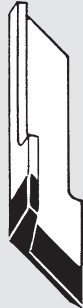

344559 (CT)



377465 (CT)



377559 (CT)  
G 6050113 C 500 (CT)

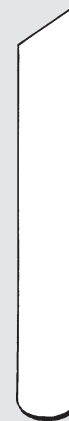

377443  
6031218 P 700



377560  
G 6050114 P 700

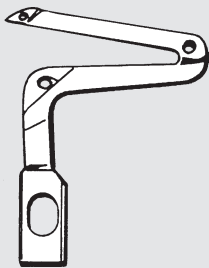

377602  
LL 603884

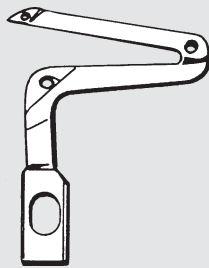

377640  
LL 604885

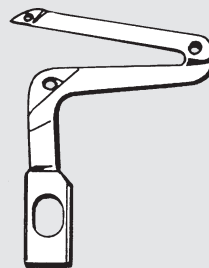

377641  
LL 604884  
LL 600884

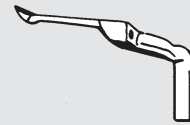

377600 (A)  
UL 603880  
UL 600880

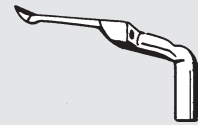

377601 (C)  
UL 603886  
UL 600886

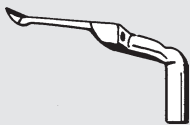

377740 (B)  
UL 603881  
UL 600881

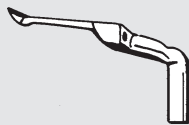

377638 (D)  
UL 604883  
UL 600883

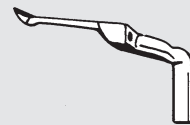

377639 (F)  
GUL 604152

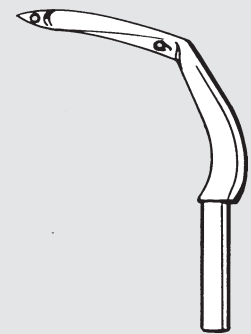

UL 605294

695 = Union Kl. 39500  
698 = Union Kl. 39800

801 U = Brother Kl. B 561  
802 U = Brother Kl. B 571  
812 U = Brother Kl. B 581  
831 U = Brother Kl. B 511

832 U = Brother Kl. B 531  
842 U = Brother Kl. B 551  
881 = Brother  
882 = Brother  
892 = Brother



727, 737, 747, 757  
700 H, 700 F, 700 FS  
700 FX



KR 35



KR 55



KR 23 (CT)



KR-23 A (CT)



KR-23 C (CT)



KR-35 C

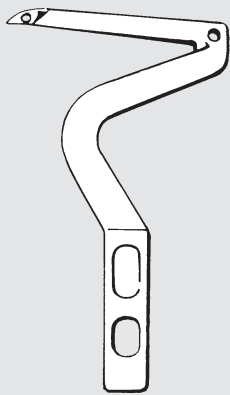

KL 25

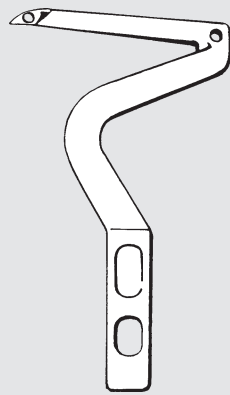

KL 25 A

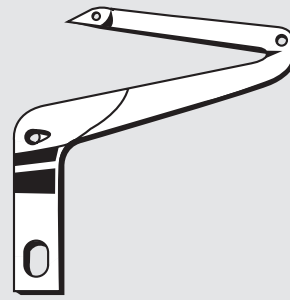

KL 65

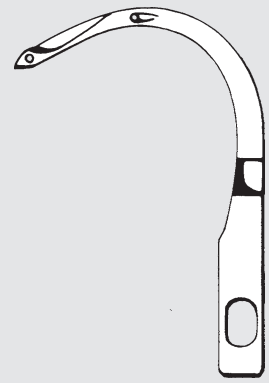

KM 04



LP 22



LP 24



LP 26



LP 36 A



**C 007**

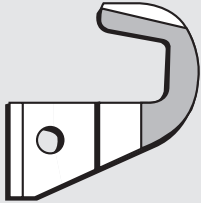

CRL 103

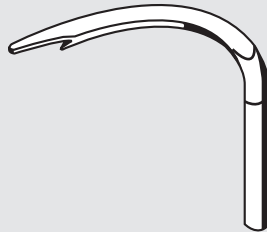

MH 41



MT 01

**F 007**

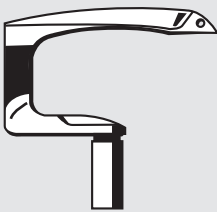

FS 03

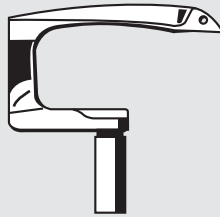

FS 04

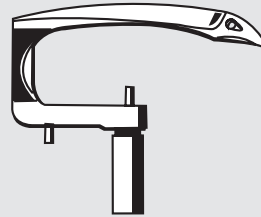

ME 28

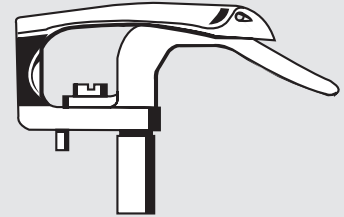

ME 28 P

**HF 008**



HE 22



FR 40



SC 88

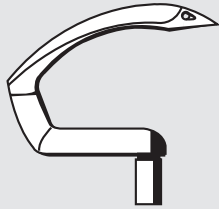

CB 28

VC 008

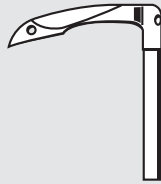

VE 51

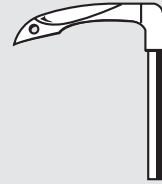

VE 51 P

Z 008

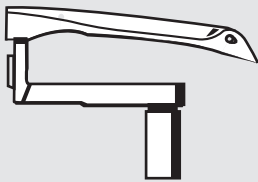

ZD 21

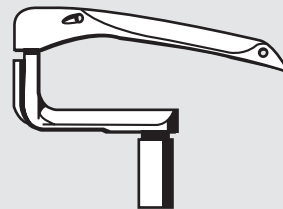

ZD 22



VLA 48-4  
(18702 Adamson)



1870053



1840096

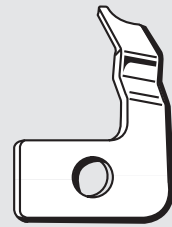

1840097

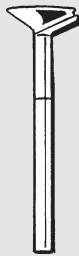

1870047  
Kl. 141-23  
-28  
410  
415



1870004  
Kl. 141-21  
-24  
-27  
-30  
-40  
-50



6300, 6600



1250004-229 B

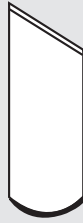

1250004-237 B



1650004-229 (CT)

AD 158

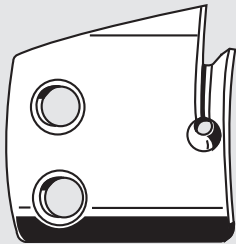

2111407-553-B

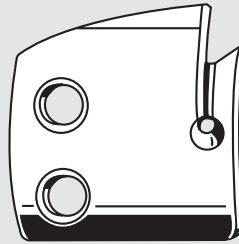

2111417-553-A



2111417-556-B

Treasure



11837 (T 830)  
96-795104-00



11563



15111-A



**2100, 2200**

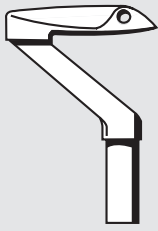

2108

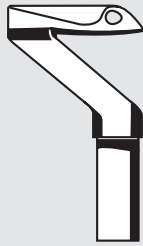

2108 G

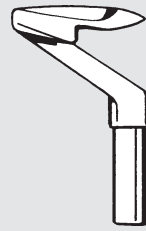

2108 A



2108 B



2111



2149 (AB)



2170 (AA)

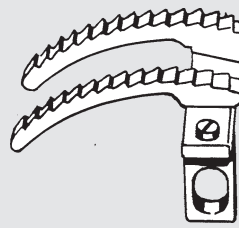

2105

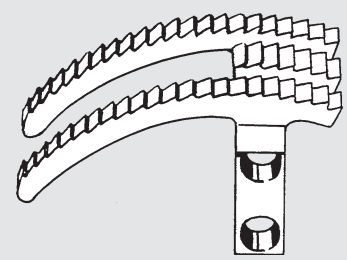

2126

**2000  
3000**



2008 K (UX)



2008 Q (UXA)  
3008 Q

**33700**

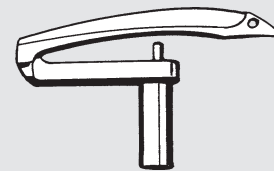

33709 C

**35600, 35700, 35800**



35796 B

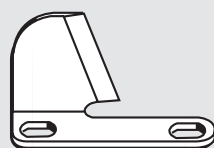

35796 C

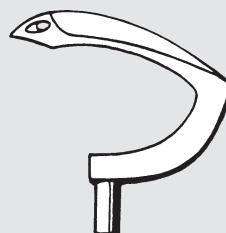

AV = 35809 AY



AU = 35808 AY

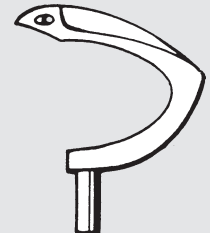

AY = 35809 BY





34700, 34800  
92800, 93800, 94800

Serie CS + FS Seite 109  
page 109  
pagina 109



34709 (UR)



34709 D (URD)



34770 K  
34770 M

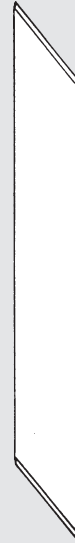

34749

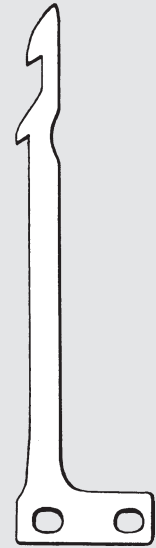

34749 K  
34749 M  
34749 P

36200 Flatseamer

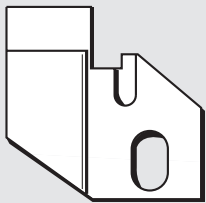

999-302 N 1033



36250 SUPER  
A 10469

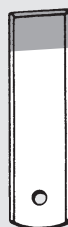

G 36250  
= CT 36250

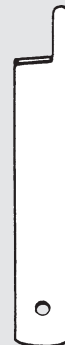

36270 SUPER  
36270 B  
A 10470



CT 36270

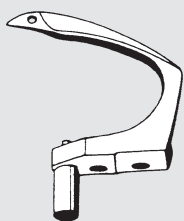

36208 A

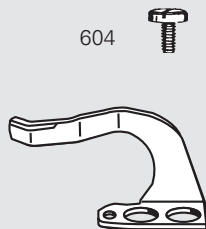

604

36210

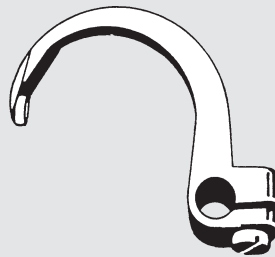

36251 F



36251 FD



36251 E (A)



36251 W

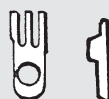

36240 (D)



G 36240 (VD)



39500

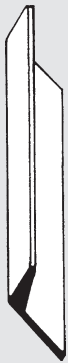

G 39570  
39570

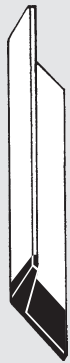

CT G 39570



39570 SC  
Solid carbide  
Metal sólido duro

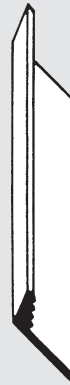

G 39570 A  
(A 9181)

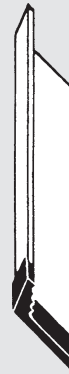

A 9392 (CT)



G 39570 JU  
(A 9259)



39570 J



CT 39570 J



39570 K

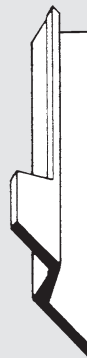

39570 L

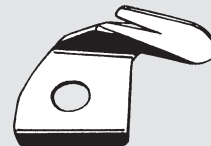

39556 K



39556 L



39549

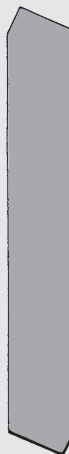

39549 BAK  
Ceramic

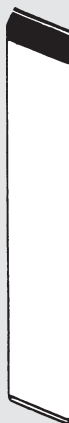

G 39549 N (CT)



39549 SC  
Solid carbide  
Metal sólido duro

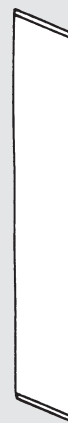

G 39549 JU  
(A 9071)



G 39549 SU (CT)



39549 J



39500



CT 39549 J

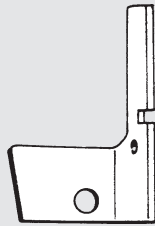

99669 K (GM)

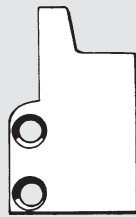

99670 L



99669 (GC)

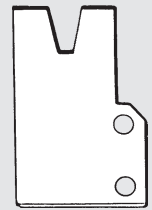

99670 (GD)



39508 B

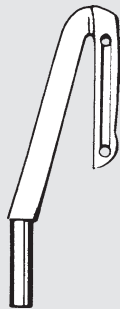

39508 D

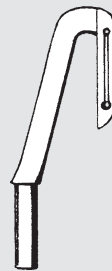

39508 P



39560 B

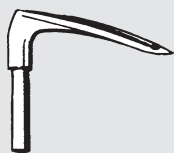

39508 A (CC)  
G 39508 A (UM)

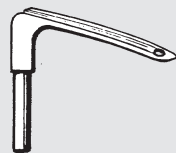

39508 E (CK)



G 39508 AV (GC)  
(A 9050)

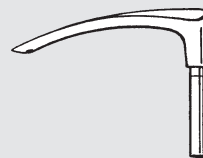

39508 C

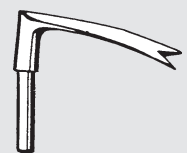

39560 A (E)

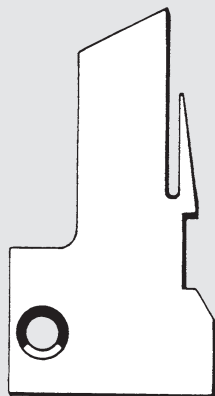

39524 AB 1/8  
(AX 1/8)  
ohne Transporteurschlitz

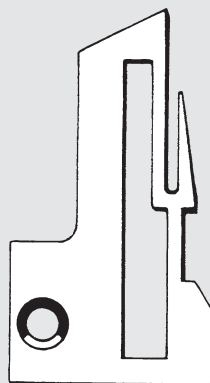

39524 AB 1/8  
(AX 1/8)

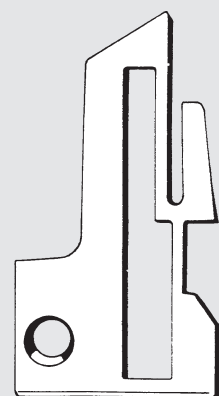

39524 AB 5/32  
(AX 5/32)



**39500**

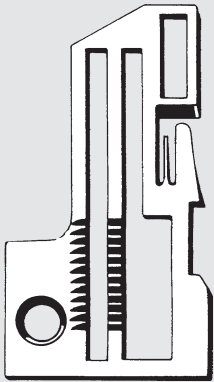

G 39524 AV (GB)

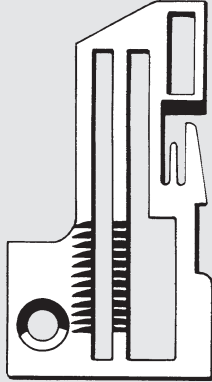

G 39524 AW (GC)  
GB 39524 AW (HN)

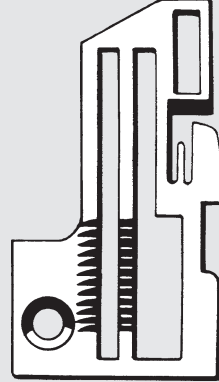

GA 39524 AW (HH) 5/32

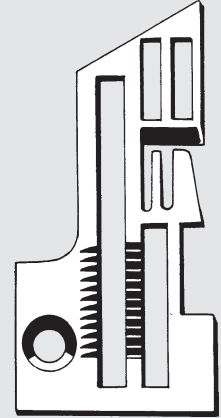

39524 W (AN)

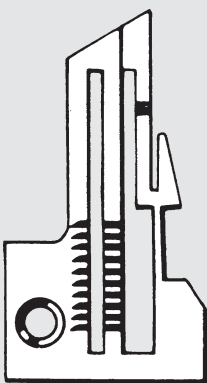

39524 B 3/32  
(V 3/32)

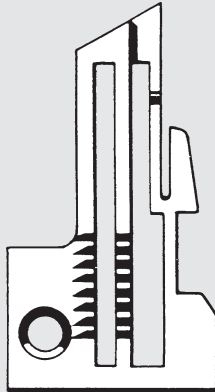

39524 B 1/8  
(V 1/8)

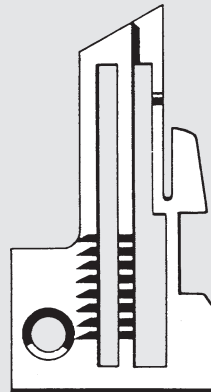

39524 B 5/32  
(BH)

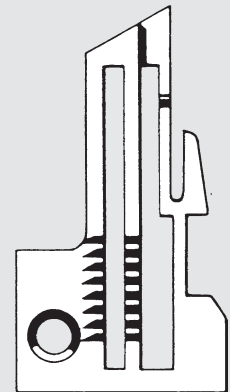

39524 P  
(AJ)

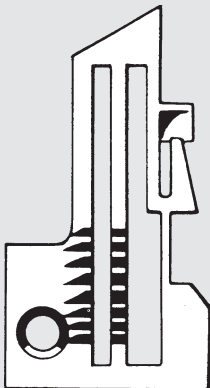

39524 C 1/8  
(AC 1/8)

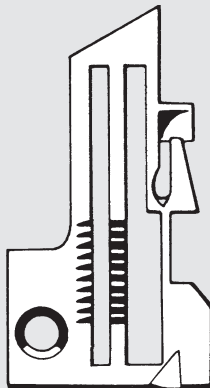

39524 C 5/32  
(AC 5/32)

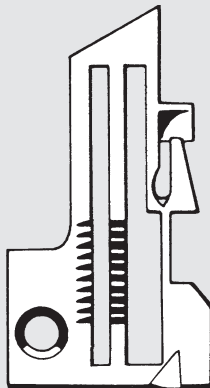

A 9953 1/8  
(HV 1/8)

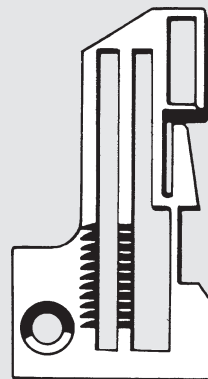

GA 39524 C 1/8 (HB)

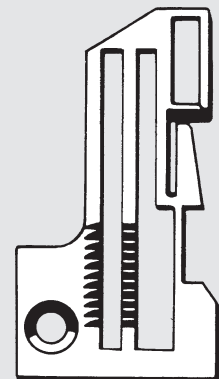

GA 39524 C 5/32 (HC)



39500

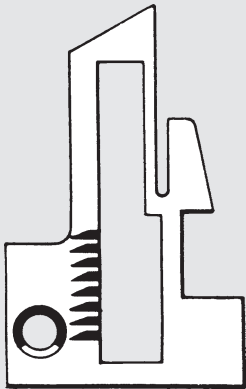

39524 J

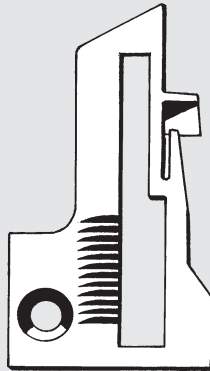

39524 AS (BE)

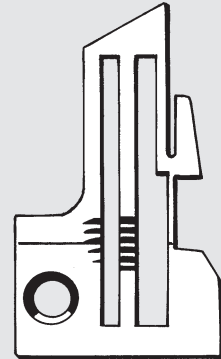

39524 D (AM)

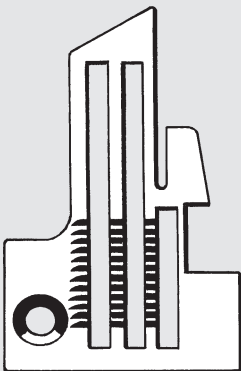

39524 N (AH)

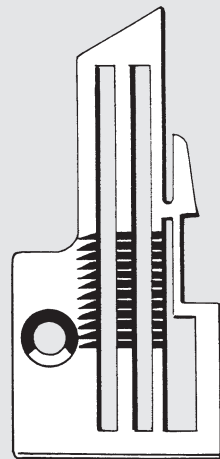

39524 BF 1/8 (BK)

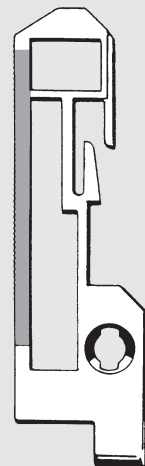

A 9608 B (HG)

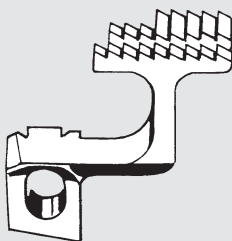

39526 AW

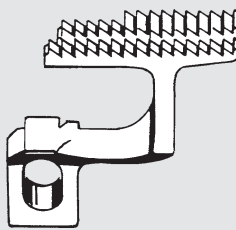

39526 B



39505 B



**39800**

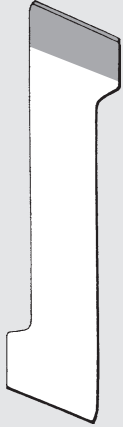

CT 39849

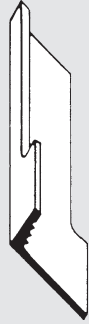

39870

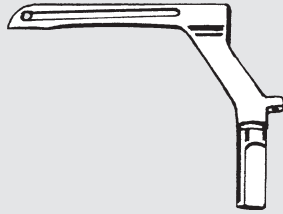

39808 CY

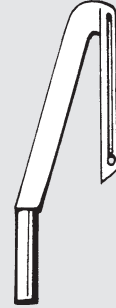

39808 D (ACZ)

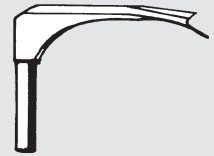

39860 H

**SP 151, SP 161, SP 172**

= Juki

Seite 29–33  
page 29–33  
pagina 29–33



118-45906

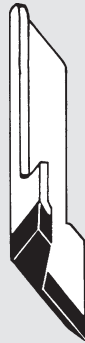

CT 118-45807



122-20307

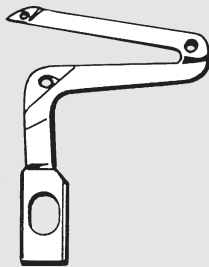

122-40107

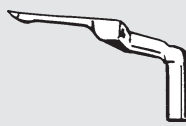

122-47508



**39200**

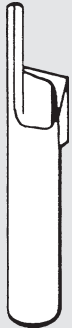

39270 A



39270 D



39270 E  
KI. 39200 / 39600

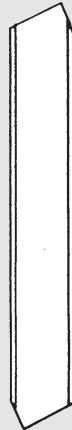

39249 A



39249

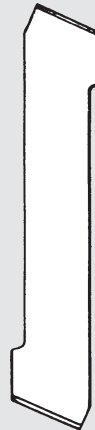

39249 K

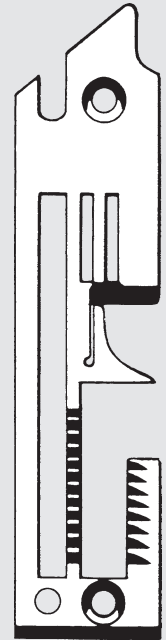

39224 AC 3/32  
39224 AC 1/8  
39224 J  
39224 AA

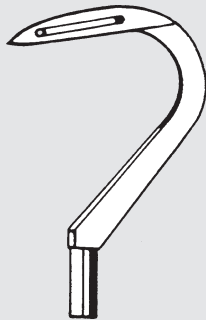

39208 B

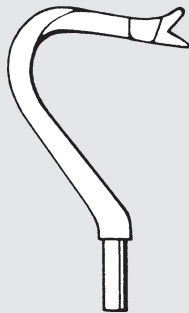

39160

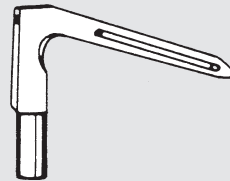

39208 AA

**FS 122, 123, 132, 133, 311, 312, 322, 323, 332**  
**CS 122, 132**  
**92800, 93800, 94800**  
**MFC 7000 Series**  
**MF 7000 Series**

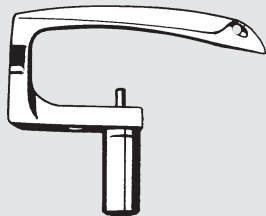

52708 B



34770 K  
34770 M



34770 EL



34709 D (URD)

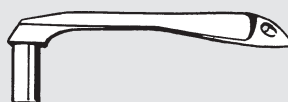

34709 (UR)

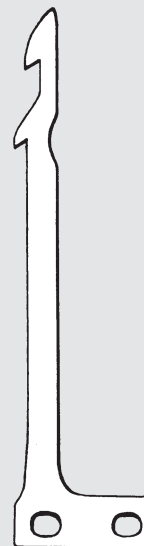

34749 K  
34749 M



34749 EL



**41300**

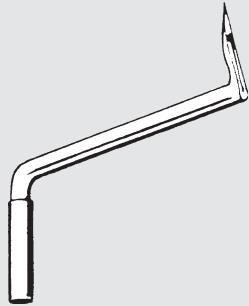

41308 BX = 41309 A

**51200**



51249 B



51270 S

**51700, 56700**

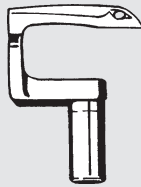

51708

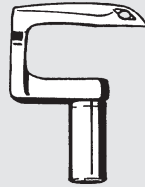

51709

**52700**



52770 C (B)  
52770 D (E)



52749 A

**57700**



57770 A (D)



57949

**J 200**



0085168





## 52700 BKZ Galkin

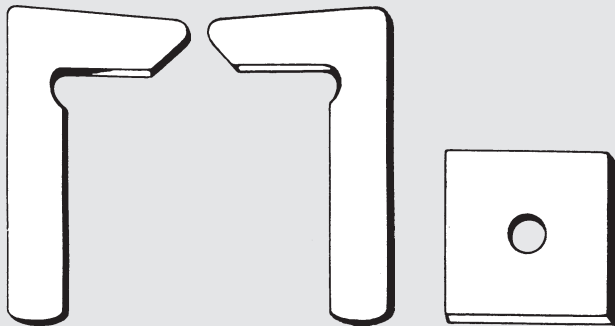

167 L  
CT 167 L

168 R  
CT 168 R

169

## 57700 BKZ Galkin

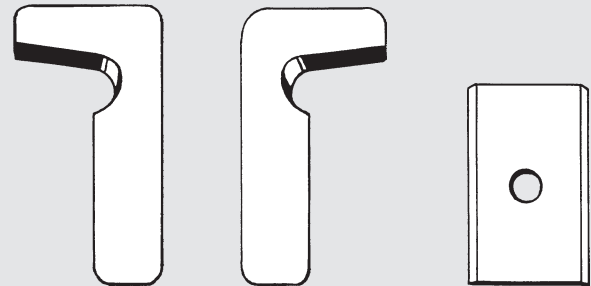

CT 11110

11111  
CT 11111

CT 11109

## 53100

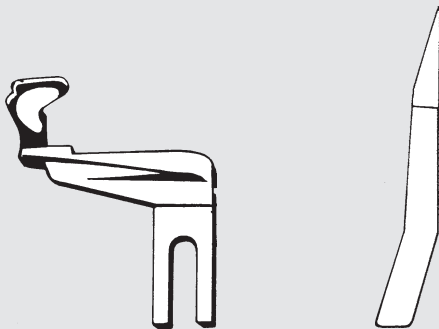

G 53170 R

9949 AR

## 53300, 53400

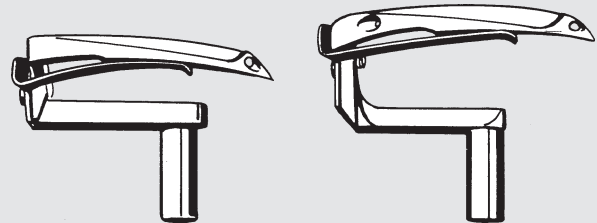

53407

53409

## 54200, 54400

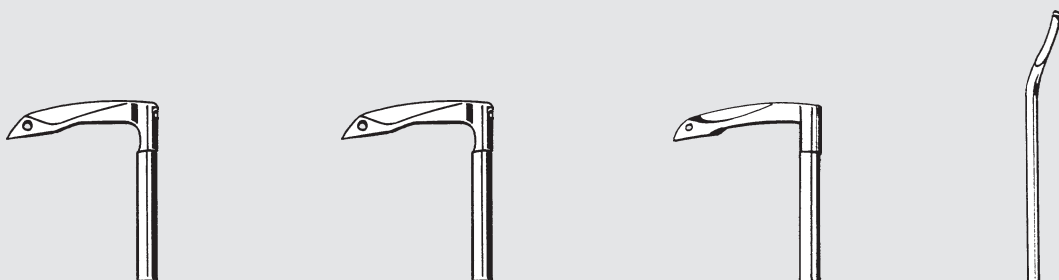

54208 B

54208 (BZ)

54208 A (CB)

54211 A



52700, 52800, 52900  
57700, 57800

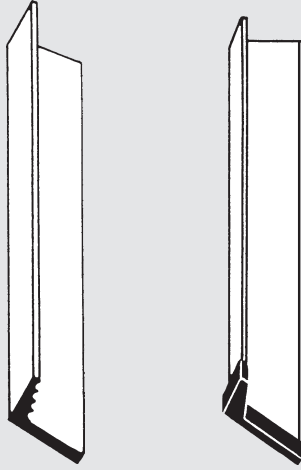

52970 E

A 9464 (CT)  
= 52970 D (CT)

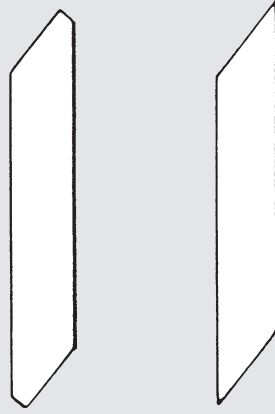

52949 A

52949

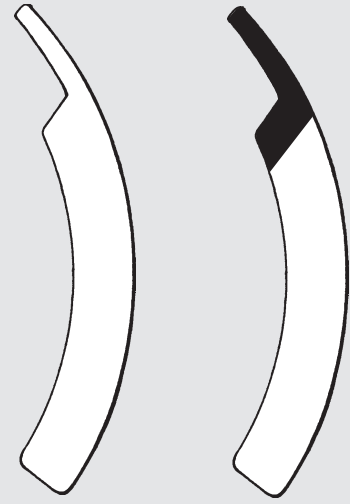

52970 C

CT 52970 C

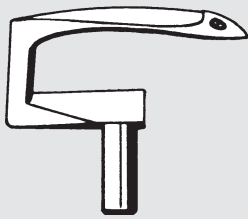

52808 E

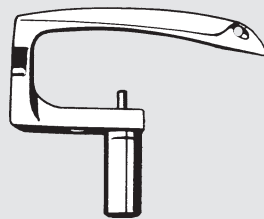

52708 B

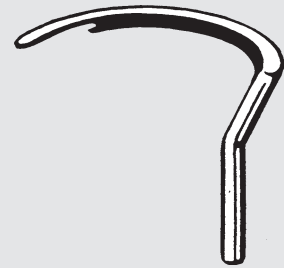

52845 A (B)  
= 52945 M (F)

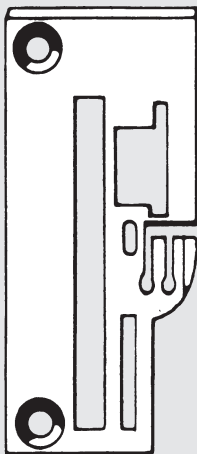

G 52928 A 5-8

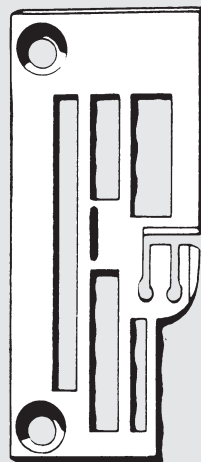

52928 A 16-8

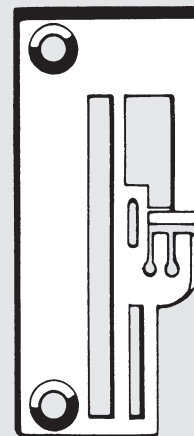

52924 BH 5-8



51400, 51408, 51900, 52300, 52900  
XF 500, LF 611  
53700, 53800, 56900

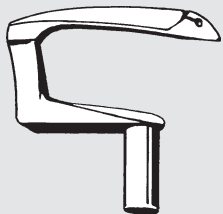

G 51409 C

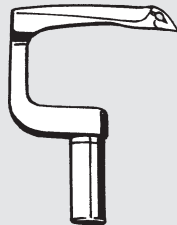

51409

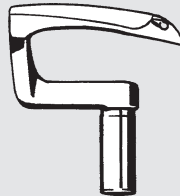

51408-12

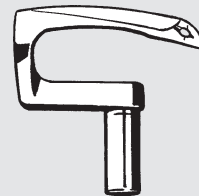

51408-16

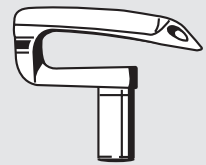

51508 M-18

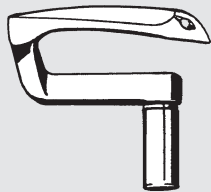

51908 B-8

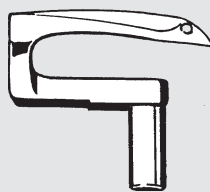

51908 B-9

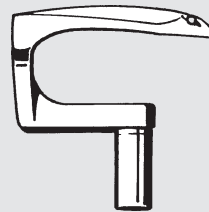

51909 C

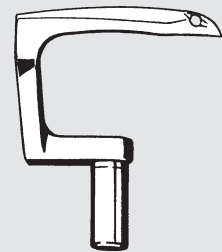

51909 D-9



51470



51449



CT 51449



52949 B

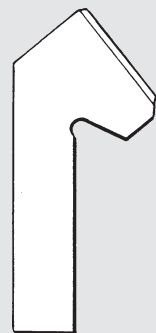

A 9540



15400



15470



15449



15408 A



15408 G



15460

75400



75449



75470 LA



75449 LA

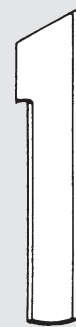

75449 LB  
75449 LA

Lewis



36-16  
Kl. 150



36-19  
Kl. 156-20



36-21  
Kl. 200

51100

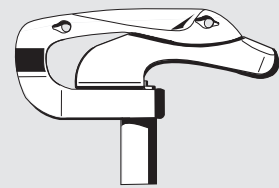

51108 DA



81200, 80200, 80600, 80700  
80800, 81300 A, 81500

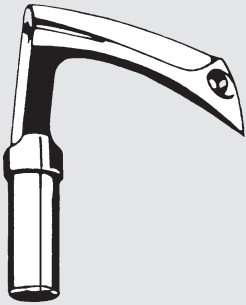

AS 26 XA

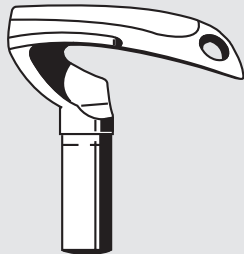

A 8375

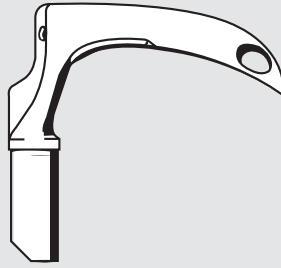

A 8376

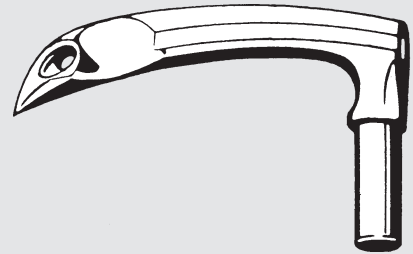

81208



81508



81311 B

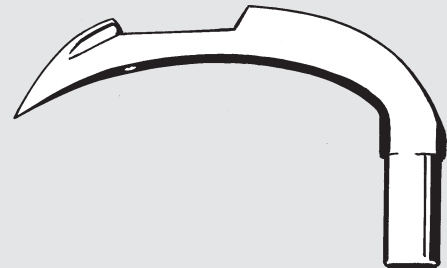

81308 B

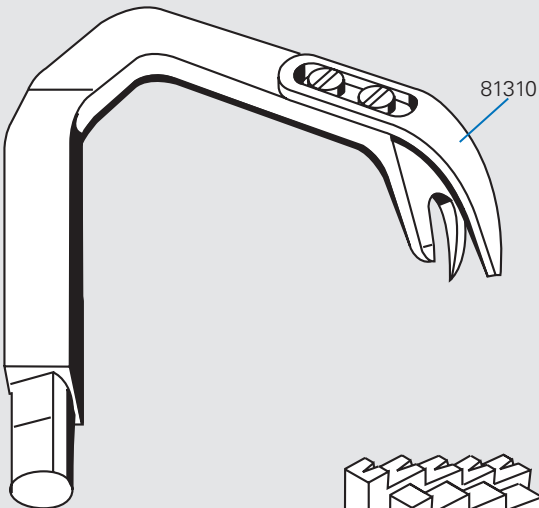

81507

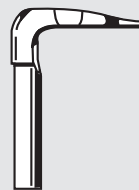

81511

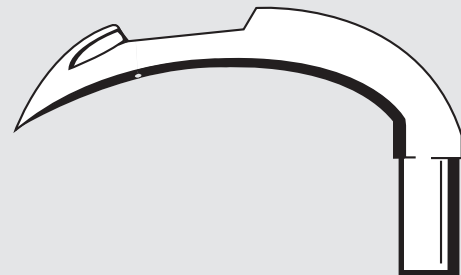

81308 C

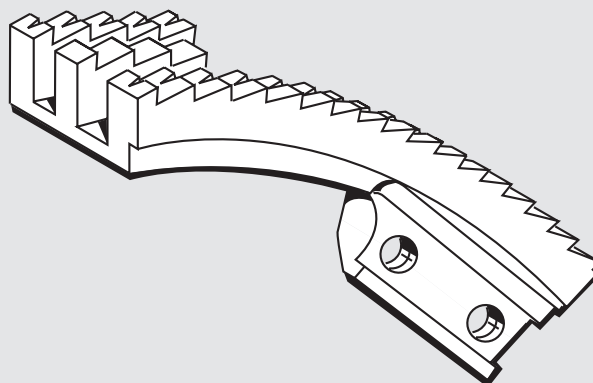

81326



81200, 80200, 80600, 80700  
80800, 81300 A, 81500

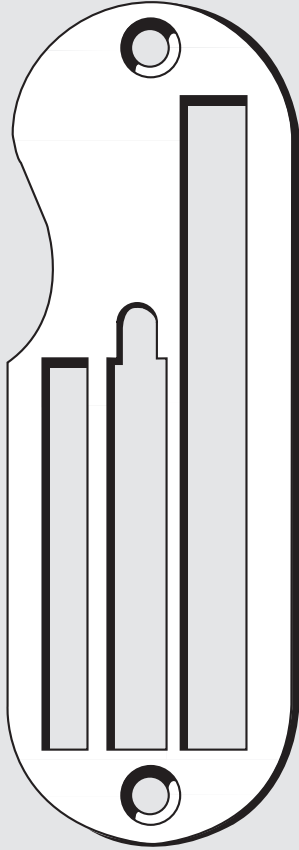

80224

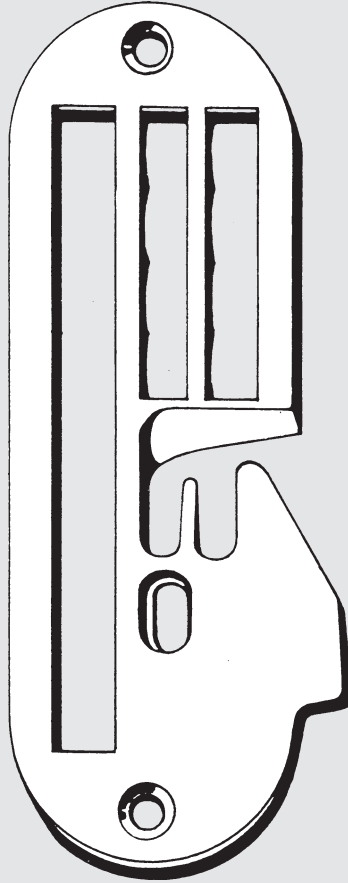

81224 AB

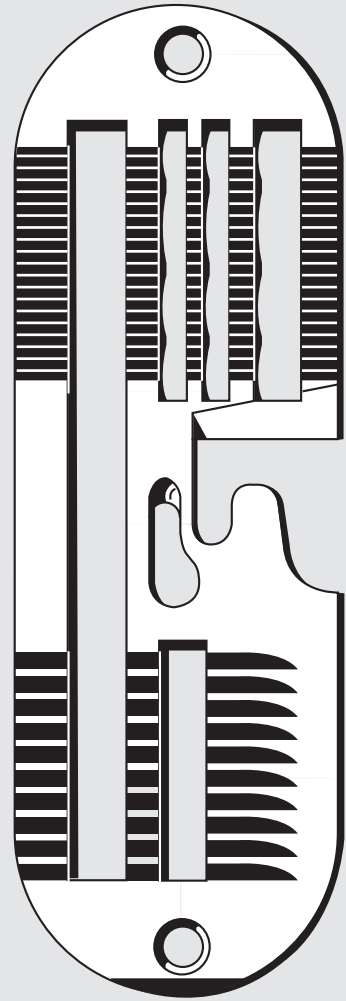

81324 A

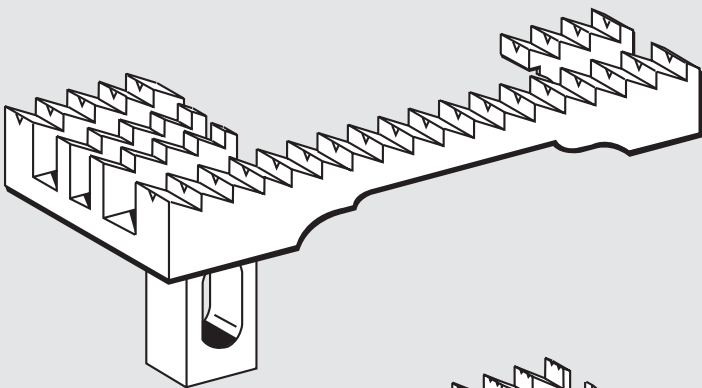

81305 A

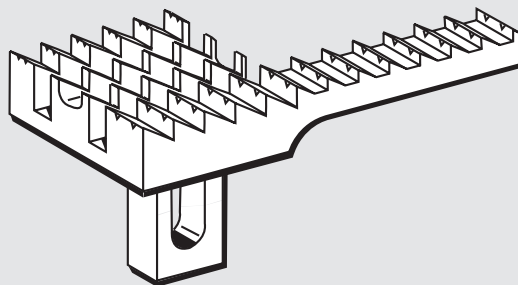

80205

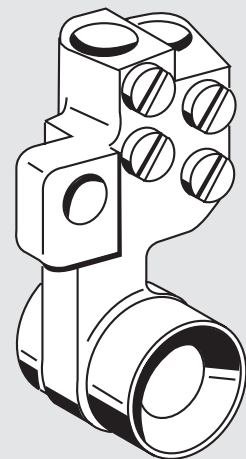

A 8377



**Overlock**



1662



1657

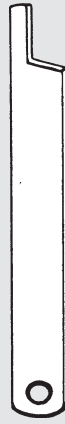

1662 A

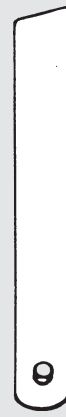

1655



5350

**1301, 1311 Flatlock und Feldlock**



3544 A (HSS)  
312-870-003



CT 3544 A  
312-870-004



3543 (HSS)  
312-870-001



CT 3543  
312-870-002



3018  
312-800-026

**503, 504, 514, 515, 516  
E 32, E 52, E 56 etc.**

siehe Pegasus  
see Pegasus  
véase Pegasus



**800, 1412 Superlock**



D 110-10  
313-870-003  
CT D 110-10



D 119-10  
CT D 119-10



D 110-8 A  
313-870-015  
CT D 110-8 A



D 119-7  
313-870-002  
CT D 119-7



441031 (CT)  
313-870-005 (CT)



442001  
313-810-012

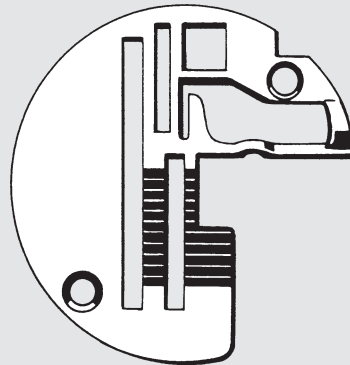

D 250-17 B

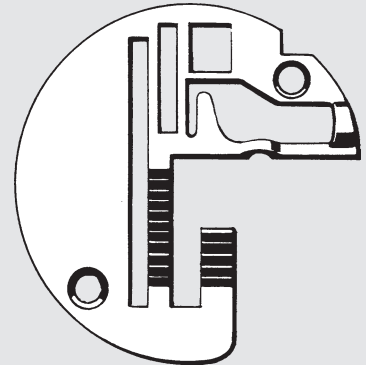

D 250-18 A  
313-801-025



D 60-3  
313-810-010



D 80-4  
313-810-001

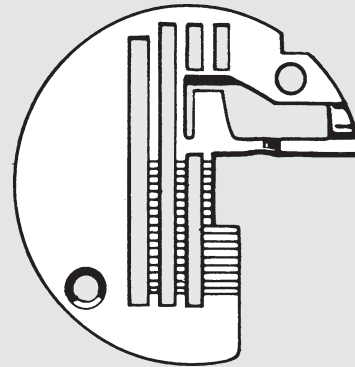

D 250-39  
313-801-036





DCZ 203, 220, 222  
DC, DCY, DCZ 221, 331, 341, 428, 520, 521  
Z 830, 831, 833  
Z 610

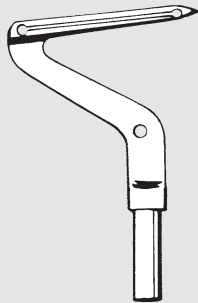

34392  
32790

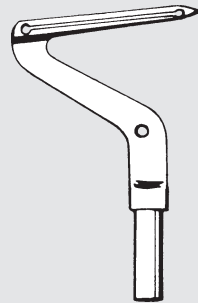

34393  
32415

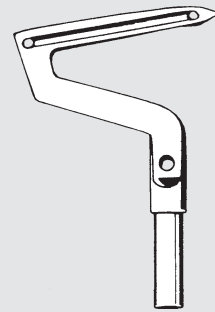

32541

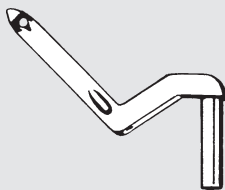

35227  
32539

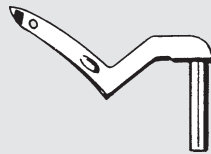

34730  
34599

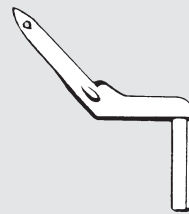

32807

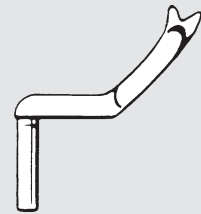

32813



34113

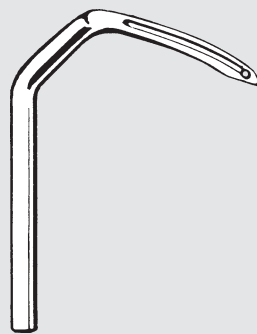

33059

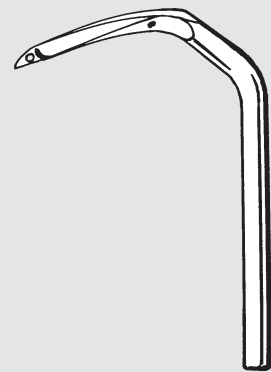

31877

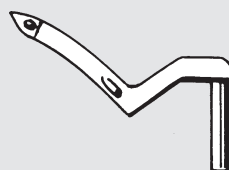

34519

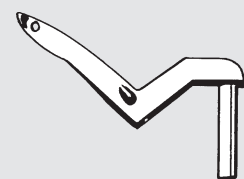

34584



**DCZ 203, 220, 222**  
**DC, DCY, DCZ 221, 331, 341, 428, 520, 521**  
**Z 830, 831, 833**  
**Z 610**

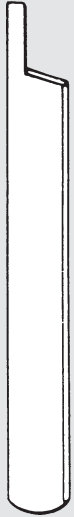

37514



CT 37514



37538

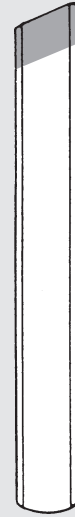

CT 37538



30421



38332



35285



32914 (CT)

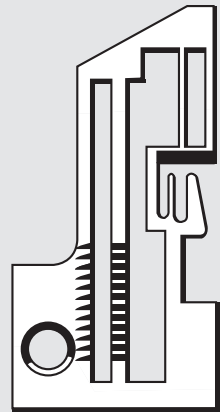

33821

**VT 2500**



4301125

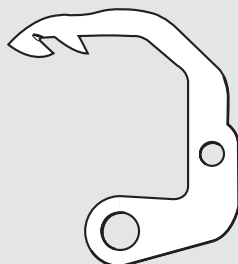

4301119

**DW 1802, 1804**

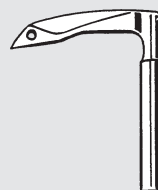

66601



**DT 30  
VX 2400, 2500**

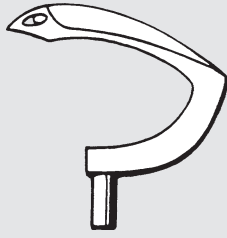

69085



69084

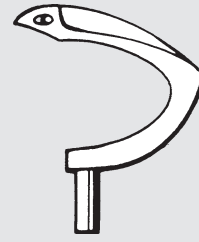

69086

**FD-62 Flatseamer**



68184 SUPER



CT 68184

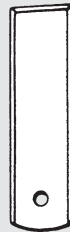

68121 SUPER

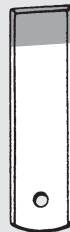

CT 68121

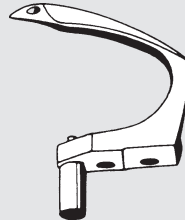

68217



4284



68218

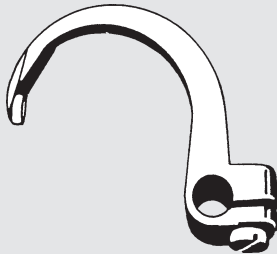

68124

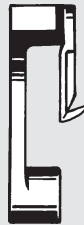

3021092  
68124 SF  
= Kl. FD-62-07 MS

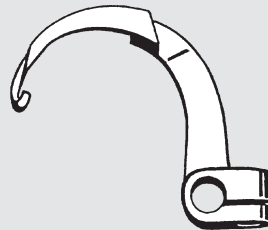

68123



68560

**CB 201-234  
CB 501-544**



85168

**CM-263, CM-268, CM-364  
CM-352, CM-474**



80413

**46, 47**

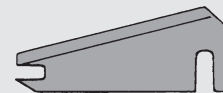

15487 Ceramic



**Z 1000, ZF 1000, Z 1500 Series**  
**Z 2000, Z 3000, Z 5000, Z 6000 Series**  
**AZ 6000, AZ 8000 Series**  
**AZF 8000 Series**  
**AZG 8000 Series**  
**CZ 6000 Series**



CT 20491 G



CT 20491

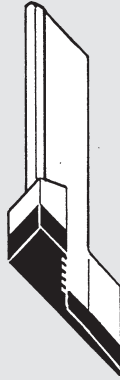

2121107 (CT)



20496 (CT)  
6200022

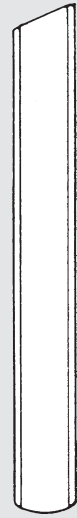

20498



2121111



2100167  
6200097



2101091



2110305



14136  
KI. ZF 1500



20271

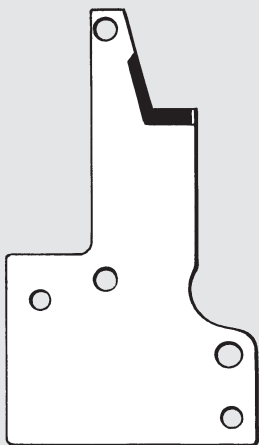

2111055 (CT)

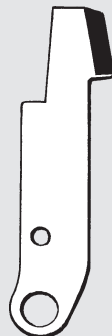

2111056 (CT)

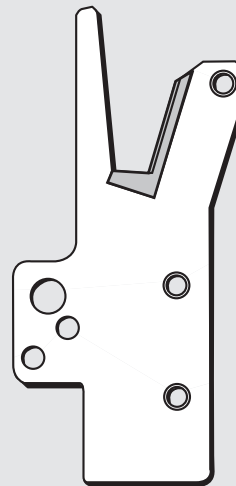

2101155 (CT)

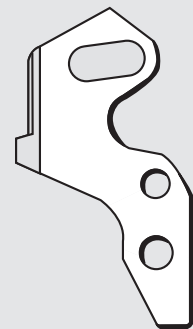

2101156 (CT)



Z 1000, ZF 1000, Z 1500 Series  
Z 2000, Z 3000, Z 5000, Z 6000 Series  
AZ 6000, AZ 8000 Series  
AZF 8000 Series  
AZG 8000 Series  
CZ 6000 Series

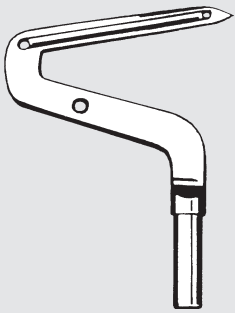

21701

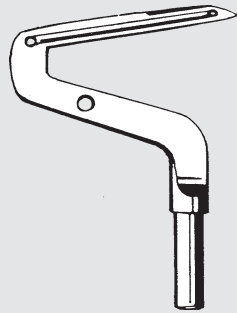

21757

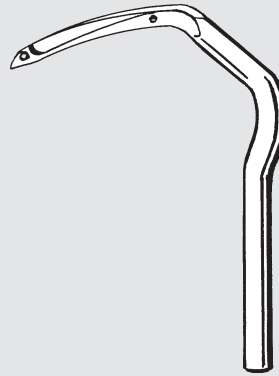

25046  
20378

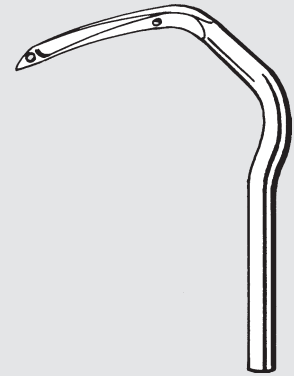

20577

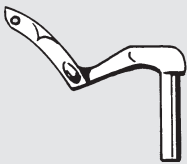

21756

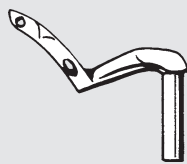

21700

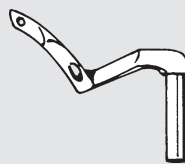

27012

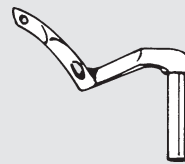

27013

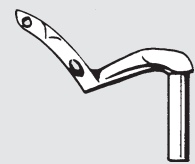

21754

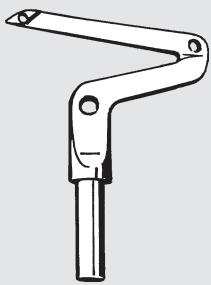

2109300

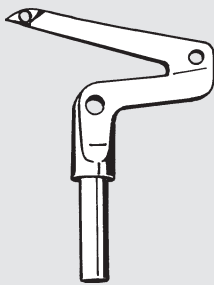

2109331  
2109348

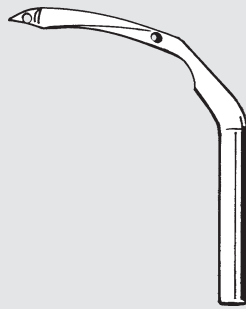

2109302



2109301



2109304



2109305



2109307



2109308



2109309



2109310

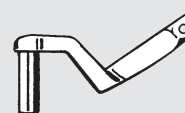

2109320

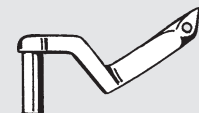

2109322  
6209300



2109328



2109341



2109343

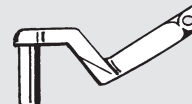

2109324

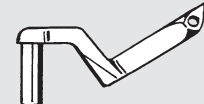

2109326



**Z 1000, ZF 1000, Z 1500 Series**  
**Z 2000, Z 3000, Z 5000, Z 6000 Series**  
**AZ 6000, AZ 8000 Series**  
**AZF 8000 Series**  
**AZG 8000 Series**  
**CZ 6000 Series**

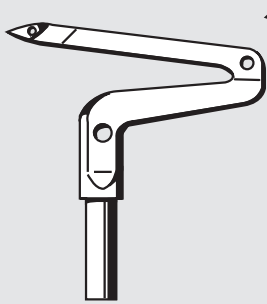

2109334

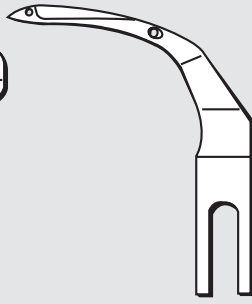

2109335

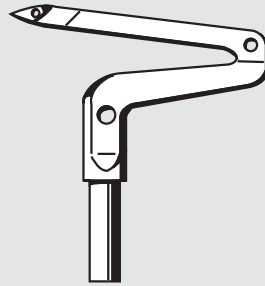

2109347  
6209301

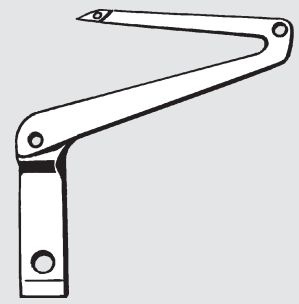

2119305

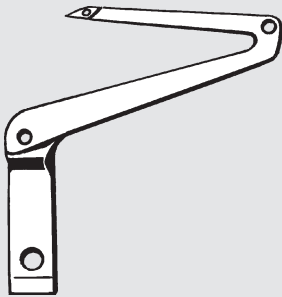

2119324

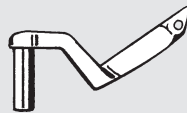

2119322 (F3)

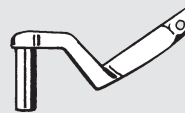

2129300

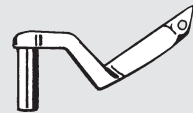

2119301 (Y1)

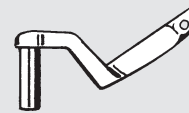

2119302 (Y2)

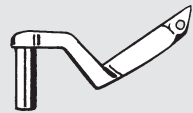

2119303

**DV 1200, 1400**  
**DW 1200, 1400**



95277

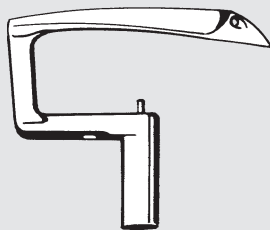

95499

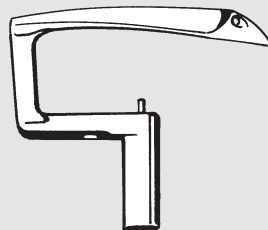

95174  
94480  
93310



95276 (CT)



94417 (CT)

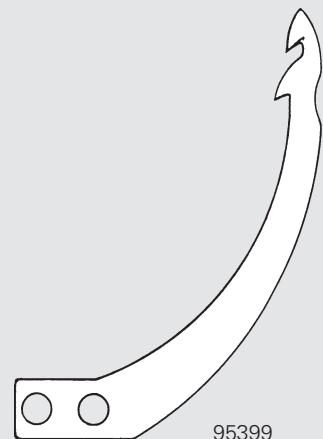

95399



**VC 2400, 2600, 2700, 2800, 3600, 3700, 3800**  
**VE 2700**  
**VF 2300 M, 2400, 2500, 2800**  
**VG 2700, 3700**  
**VGS 2700, 3700**

**CC 2700, CFZ 2300 M**  
**MG 2000, VM 1800**  
**VFS 2500**  
**VES 2700**

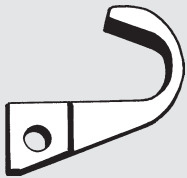

95276 (CT)



3501032 (CT)



3101633



3101607

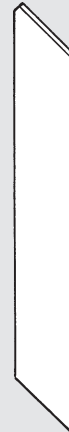

3201062



3101026



3101028 (CT)



3101465 (CT)

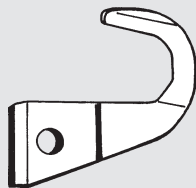

3110037 (CT)

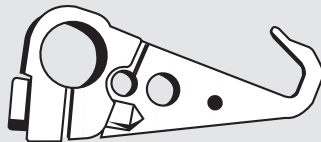

3501534

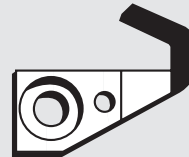

3501535 (CT)

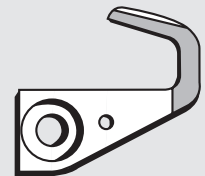

3501597



3120151



3100513



3100512



3110038

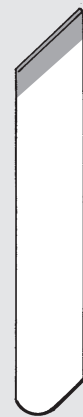

CT 3110038



3100708



VC 2400, 2600, 2700, 2800, 3600, 3700, 3800  
VE 2700  
VF 2300 M, 2400, 2500, 2800  
VG 2700, 3700  
VGS 2700, 3700

CC 2700, CFZ 2300 M  
MG 2000, VM 1800  
VFS 2500  
VES 2700

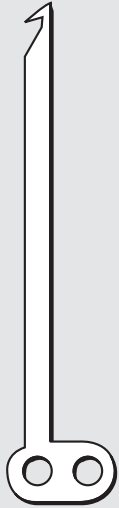

3101801

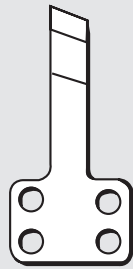

3101802



3101699



3101700



3120016



3501026



3109300

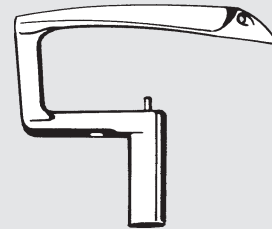

3209311



3109306

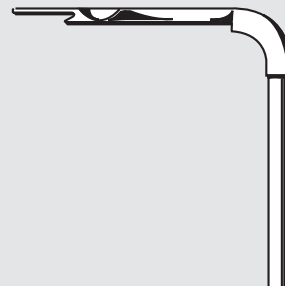

3109310





**Blindstichnähmaschinen  
Blindstitch Sewing Machines  
Máquinas de puntada invisible**



Brother  
KI. CM 2-B931  
Nr. 110121-001



Columbia  
36 C 22-1



Lewis  
36-16  
KI. 150



US  
3430-22



Strobel  
VLA 48-4  
(18702 Adamson)



Strobel  
1870053



Treasure  
11837 (T 830)  
96-795104-00



Yamato  
80413

**Barudan**

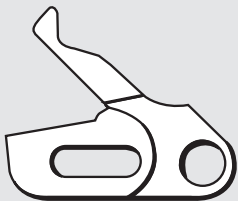

KB 270010

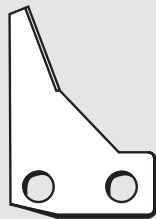

KN 270960



KN 270950  
KN 270951

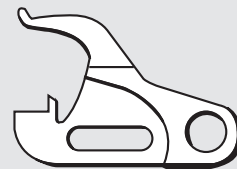

KN 270952



KN 271602  
KN 271980

**British United Shoe Machinery Co.**



KZG 502 E



KZG 757



### Clinton

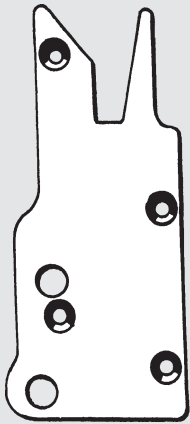

01-4434-01  
für Union 39500/39600  
W & G 504/514

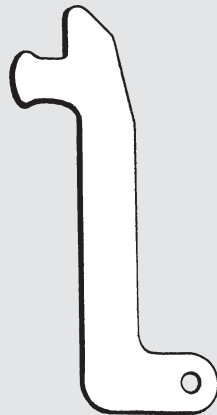

01-4435-01  
für Union 39500/39600  
W & G 504/514

### Gribetz

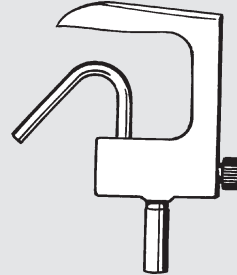

P3-0146

### Meca

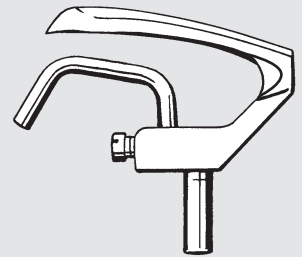

Meca

### Sotco



Sotco oben  
Nr. 514



Sotco unten  
Nr. 510 S

### Metropolitan



525 W  
Kl. 30-A

### Diamant FR

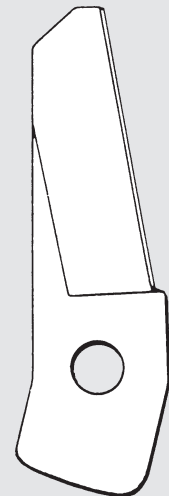

Diamant FR  
CT Diamant FR



**Kettelmaschinen (Kettma, Böttger, Sotco usw.)**



JK-R  
und VB-R  
oben rechts



JK-R  
und VB-R  
unten rechts



JK-L  
und VB-L  
oben links



JK-L  
und VB-L  
unten links



breite Kettelmesser  
rechts oben rechts unten

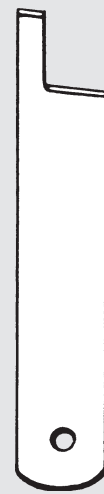

breite Kettelmesser  
links oben links unten



**Titan – Baratto**



330 ACAR (CT)

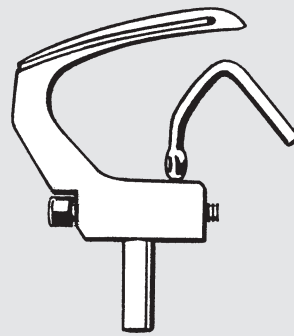

27264

**Tajima**

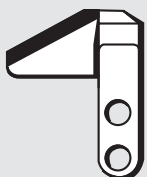

AT 0202 000 000 (CT)



AT 0204 000 000

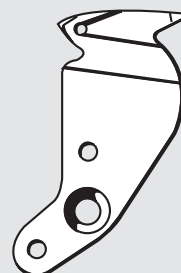

FX 0206 000 000



FX 0207 000 000 (CT)



**Pfaff**



29-924993-70/876

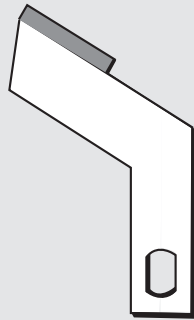

29-924993-81/957

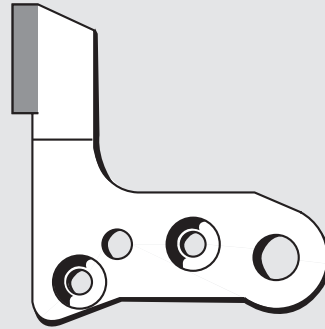

29-924993-81/704

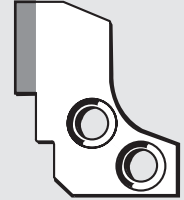

98-788013-00/900



29-924993-81/668



29-924993-71/442



29-924993-70/641



98-784045-02/000



29-924993-56



29-924993-70/299



29-924990-88

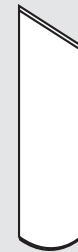

29-924992-56/100



93-415504-49

**Husquarna**



21410042-37



21410042-29



4156597-01



4156628-01



**Juki Babylock**



305249

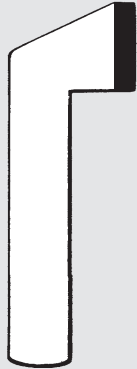

205-9102-01 A (CT)



305248



405-9102-01 A

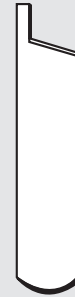

408-9101-01 B



408-9102-01 A



PL-Q11-01 A



PL-Q11-01 C



PL-R11-01 A



SE-R11-01 A



60507 (CT)



60544



B4401-03A-0Y



B4401-04A-0Y

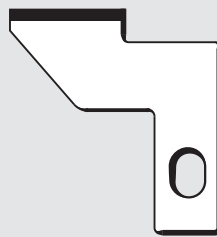

B4471-02A-0Y

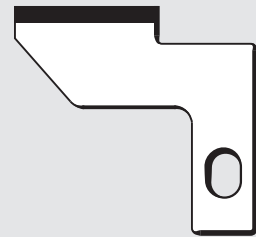

B4471-03A-0Y

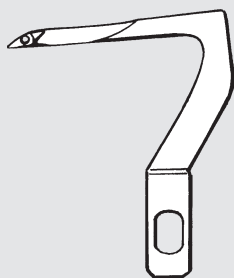

418-6101-02 A



714-6101-01 A



### Bernina (Bernette)



50143403 (CT)



50145403

### Singer



1-412749-000













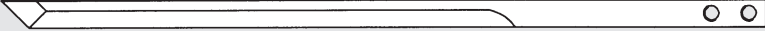
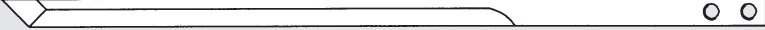
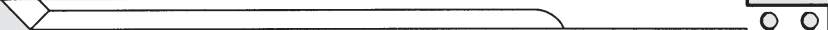

1-550449-000



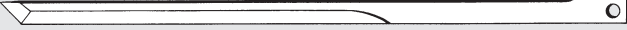

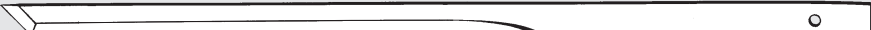
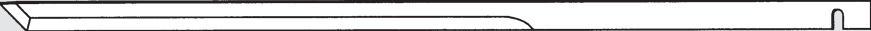

412585



<b>Bullmer</b>		105934	169 x 2,0 x 6
		103630	169 x 2,0 x 6 H hohl / hollow / hueco
		104264	201 x 2,5 x 8 G glatt / smooth / liso
		100124	201 x 2,5 x 8 H hohl / hollow / hueco
		104450	223 x 2,5 x 10 / 8
		105935	223 x 2,5 x 10 / 8 K kurzer Schnitt / short cut / corte corto
		103986	223 x 2,5 x 8 G glatt / smooth / liso
		102642	223 x 2,5 x 8 H hohl / hollow / hueco
<b>F.K.</b>			291 x 2,5 x 8
<b>Gerber</b>		G 93	175 x 1,5 x 6,3
		G 93 HPC / S 5200 1100880 / 054782004	195 x 2,0 x 7,9
		G 3000 / 3200 PN 07338700	202 x 2,1 x 6,3
		085878000 GTXL	206 x 1,9 x 7,9 / 6,4
		G 91 / G 93 / Z7 S 7200 / S 7500	254 x 2,35 x 8 Bohrung / hole / taladro
		G91 / S 93 / Z7 S 7200 / S 7500 02126109	254 x 2,35 x 8 Schlitz / slot / hendidura
		032419013	254 x 3,13 x 9,7 Heavy duty





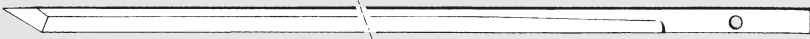
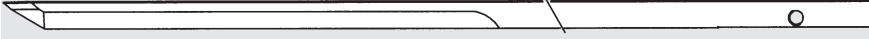





### Investronica

	CV 2	45,5 x 1,5 x 6,5
	SC 4 DIS, S 40 81700300	187 x 1,95 x 8
		245 x 2,52 x 8,3 / 7,8
	S 70817001301	245 x 3,0 x 8,3 / 7,8
	S 70817001 E 02	252 x 2,5 x 7,8 / 8,3
		291 x 2,52 x 7,85
	SC 2	296 x 2,52 x 8 K kurzer Schnitt / short cut / corte corto

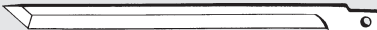
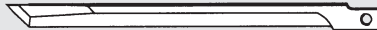
### Kuris

		84 x 1,0 x 5
	ZAT 3 Nr. 24306	178 x 2,5 x 10
	TexCut Nr. 47968	227 x 3,0 x 10,5 / 9,0

### Lectra

	Vector 2500	89 x 1,5 x 5,5
		89 x 1,5 x 5,5 / 3,5
	System 95	113 x 2,0 x 7,5 / 6
	System 95	113 x 2,0 x 7,5 / 6 H hohl / hollow / hueco
	System 95 Vector 500 / 5000	296 x 2,0 x 7
	System 95	296 x 3,0 x 8,5 / 6,5
		296 x 3,0 x 7
	116802 Vector 7000	360 x 2,4 x 7
	System 96 Vector 7000	360 x 3,0 x 8,5





**Vollhartmetall Messer / Knives solid carbide / Cuchillas metal solide duro**

**Zünd**



Z16



Z17



Z21



Z29



Z10



Z41



Z42



Z43

**Comelz**



HZ5K.S



HZ3B

**Atom**



01039999



01040445



**Bullmer**  
107506T



**Gerber**  
TL055



**Gerber**  
92831000  
Pivex 55 DEG



**Lectra**  
F0495H











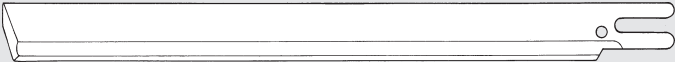
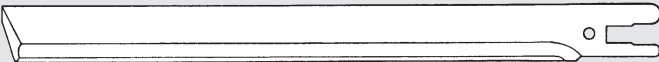
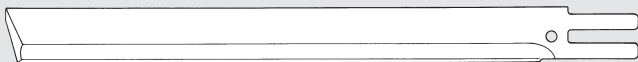

**Setec**

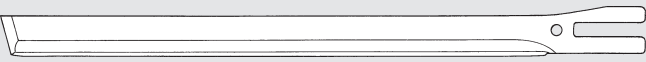
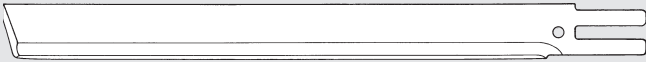
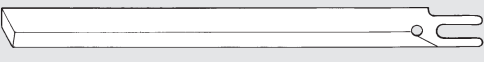
Alle Messer auch beschichtet verfügbar  
 All knives coated available  
 Disponibles todas las cuchillas recubiertas

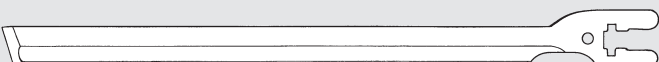
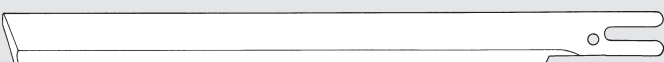

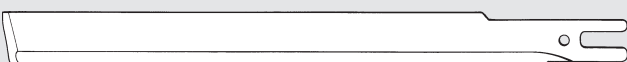
**HSS-Stahl • High-Speed-Steel • Acero rápido de alto rendimiento**

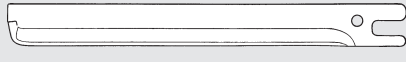
Abmessungen / Sizes / Dimensiones:

	<b>Beaver/Bullmer</b>	6", 7", 9", 10"
	<b>Comet/Gury</b>	5", 6", 7", 8", 9", 10"
	<b>Eastman/Suprena</b>	4", 5", 6", 7", 8", 9", 10", 11,5", 13", 14", 8" S 0335, 10" S 0352
	<b>Eastman Servo Cutter 16,5</b>	6", 10" gerade geschliffen = 16,5 mm ground straight at the back = 16,5 mm Lomo afilado recto = 16,5 mm
	<b>Eastman Servo Cutter 14,3</b>	6", 8", 9", 10" ausgeschliffen = 14,3 mm ground off at the back = 14,3 mm Lomo rectificado = 14,3 mm
	<b>KM/Hoogs KS-AU</b>	4", 5", 6", 7", 8", 9", 10", 11,5", 13"
	<b>KM Automatik KS-EU</b>	5", 6"
	<b>Maimin</b>	5", 6", 7", 9", 10", 11,5"
	<b>Maimin Servo Cutter</b>	5", 6", 7", 8"
	<b>Wolf</b>	5", 6", 7", 8", 9", 11,5", 13"
	<b>Kuris-KV</b>	KVW 70 / 4" 15056 KV 90 / KVW 12 / 5" 15105 KV 115 / KVW 15 / 6" 15155 KV 140 / KVW 18 / 7" 15205 KVW 20 / 8" 15256
	<b>Kuris-KV 4</b>	KV 1100 / 6" 15383 KV 1350 / 7" 15382 KV 1600 / 8" 15380 KV 2000 / 10" 15381
	<b>Kuris</b>	KVS 700 15376
	<b>Kuris</b>	KVS 900 15389
	<b>Kuris Servo Cutter</b>	SC 700 / 4" 15388 SC 900 / 5" 14237 SC 1100 / 6" 14637 SC 1350 / 7" 14637 SC 1600 / 8" 14638 SC 2000 / 10" 17627

Sämtliche Messer auch konvex/gewellt verfügbar  
All knives are also available as: convex/wavy  
Todos las cuchillas también como edición convexo





**Hoogs**



**Kuris /  
Maimin  
Suprena**



**Bullmer**

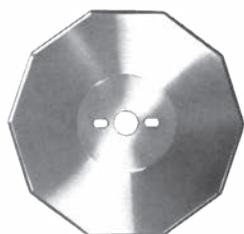

**Bullmer**

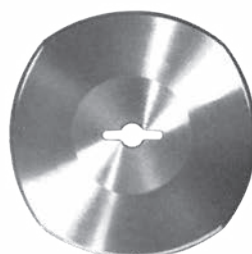

**Hoogs**

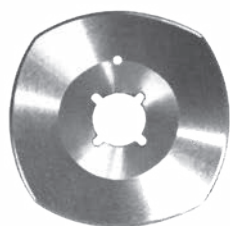

**Kuris /  
Suprena**

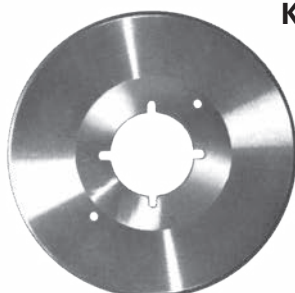

**Kuris**

Für Fabrikat For Machines Para producto	Messerform Shape of knives Forma de la cuchilla	Außen Ø Outer dia. Diámetro exterior mm	Bohrung Hole Espesor mm	Stärke Thickness Taladro mm
---	---	---	----------------------------------	--------------------------------------

**Bullmer**

604, 801	für 0470/1	10-kant -sided -cantos	59	10	1,0
601, 605	für 0570/1	10-kant -sided -cantos	79	10	2,0
607	für 0674/1	rund round circulares	100	10	1,5
606, 607, AV 300	für 0670/1	10-kant -sided -cantos	100	10	2,0
	für 675/1	4-Bogen -curves -arcos	100	10	2,0
	für 970	4-Bogen -curves -arcos	110	15	1,5
608, 609	für 840R	rund round circulares	126	45	1,0
	für 870/1	10-kant -sided -cantos	126	45	1,0

**Hoogs**

Piccolo, Liliput, Favorit	MS-3	10-kant -sided -cantos	50	25x10x4	1,2
Piccolo, Liliput, Favorit	MS-2	4-Bogen -curves -arcos	50	25x10x4	1,2
Piccolo, Liliput, Favorit	MS-55	7-Bogen -curves -arcos	50	25x10x4	1,2
IAK, IAG, Goliath	MS-10	rund round circulares	60	25x10x4	1,2
IAK, IAG, Goliath	MS-11	4-Bogen -curves -arcos	60	25x10x4	1,2
IAK, IAG, Goliath	MS-12	10-Kant -sided -cantos	60	25x10x4	1,2
Z+St	MS-20	rund round circulares	110	25x10x4	1,3
Z+St	MS-21	4-Bogen -curves -arcos	110	25x10x4	1,3
Z+St	MS-22	10-Kant -sided -cantos	110	25x10x4	1,3
X-130, X-130-N	MS-28	rund round circulares	130	25x10x4	1,5
X-130, X-130-N	MS-29	4-Bogen -curves -arcos	130	25x10x4	1,5
X-130, X-130-N	MS-30	10-Kant -sided -cantos	130	25x10x4	1,5

**Kuris**

Novita	15780	rund round circulares	50	16	1,0
Novita	16110	6-Bogen -curves -arcos	50	16	1,0
Supernovita		rund round circulares	57	16	1,0
Supernovita		6-Bogen -curves -arcos	57	16	1,0
BOM 60	15752	rund round circulares	60	22	1,0
BOM 60	16002	4-Bogen -curves -arcos	60	22	1,0
BOM 30/80	15762	rund round circulares	80	22	1,0
BOM 30/80	16012	4-Bogen -curves -arcos	80	22	1,0
BOM 30/80	16092	6-Bogen -curves -arcos	80	22	1,0
BOM 30/80	16162	8-Bogen -curves -arcos	80	22	1,0
BOM 100/101	15772	rund round circulares	100	22	1,0
BOM 100/101	16022	4-Bogen -curves -arcos	100	22	1,0
BOM 100/101	16102	6-Bogen -curves -arcos	100	22	1,0
KRH 10	15712	rund round circulares	100	35	1,2
KRH 10	16042	4-Bogen -curves -arcos	100	35	1,2
KRH 12, KRT 120	15722	rund round circulares	120	35	1,2
KRH 12	16052	4-Bogen -curves -arcos	120	35	1,2
KRH 15	15732	rund round circulares	150	35	1,6
KRH 20	15742	rund round circulares	200	40	2,2
KRH 20	16172	4-Bogen -curves -arcos	200	40	2,2
Champion CRA	15802	rund round circulares	100	8	1,3

Gegenschneidklingen siehe Seite 138  
Counterknives see page 138  
Contracuchillas véase página 138



### Eastman



### Maimin

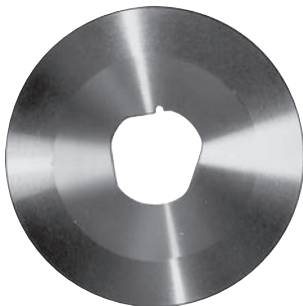

### Wolf

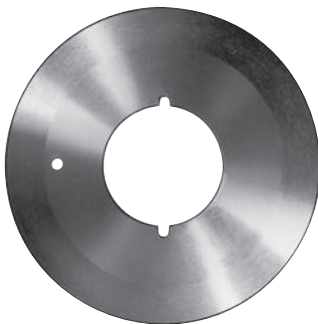

### Rasor



Für Fabrikat For Machines Para producto	Messerform Shape of knives Forma de la cuchilla	Außen Ø Outer dia. Diámetro exterior	Bohrung Hole Espesor	Stärke Thickness Taladro
Type		mm	mm	mm

### Eastman

080 C 01-147	2 1/4"	Chickadee	rund	round	circulares	57	16	
26	3 1/2"		rund	round	circulares	90	28	
59	4"	Falcon IV, Track, Robin	rund	round	circulares	101,6	40	
101	5"		rund	round	circulares	127	40	
61	5 1/4"	548/355-61	rund	round	circulares	133,6	51	
39	6"	548/562/567	rund	round	circulares	152,6	51	

### Maimin

Minishear 2"			rund	round	circulares	50	16	
Minishear 2"			6-Bogen	-curves	-arcos	50	16	
Minishear 2"			8-Bogen	-curves	-arcos	50	16	
ACD	2 1/2"		rund	round	circulares	63,3	21,6	1,0
ACDC	6"		rund	round	circulares	152,5	58,2	1,4
ACDC	7"		rund	round	circulares	178		

### Suprena

M702			rund	round	circulares	50	16	
M700			6-Bogen	-curves	-arcos	50	16	
M703			8-Bogen	-curves	-arcos	50	16	
R742			rund	round	circulares	80	22	
R1512			rund	round	circulares	100	22	
R1514			4-Bogen	-curves	-arcos	100	22	
R1513			6-Bogen	-curves	-arcos	100	22	

### Wolf

PUP	25260		4-Bogen	-curves	-arcos	52,5	17,6	1,0
SRN	2 1/2"		rund	round	circulares	64		1,0
Clipper	4"	23 einfasig	rund	round	circulares	102	31,75	1,0
Clipper	4"	23 zweifasig	rund	round	circulares	102	31,75	1,0
Clipper	4 3/4"	22	rund	round	circulares	121	42,5	1,0
Blazer	5 1/4"	21	rund	round	circulares	134	42,5	1,0
SLIM JIM	5 1/4"	24	rund	round	circulares	134	50	1,0
Blazer-0	6"	18	rund	round	circulares	153	50,8	1,2
BIG-0	10"		rund	round	circulares	254	50,8	1,7

### Diverse

Allstar 100 AS-1026			6-Bogen	-curves	-arcos	50	12,7	
KM RS 100			rund	round	circulares	100	21	
KM RS 100 OCTA			8-Bogen	-curves	-arcos	100	21	
Rasor Extra 86 C			rund	round	circulares	86	22,4	
Rasor Extra D 100 C			rund	round	circulares	100	22,4	
SULEE Modell 260			=Hoogs Z+St					
			rund	round	circulares	110		
Secat			rund	round	circulares	67	22,4	1,0
Secat			10-Kant	-sided	cantos	67	22,4	1,0

Weitere Kreismesser fertigen wir nach Muster oder Zeichnung  
We produce further knives according to sample or drawing  
Producimos más cuchillas circulares según muestra o dibujo

Alle Messer sind auch in HSS verfügbar  
All knives are available in High-Speed-Steel  
Todos las cuchillas también en acero rápido de alto rendimiento



**Bullmer**

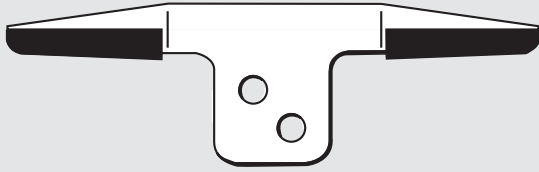

014694



014245

**Hoogs**



UM-5

501-138-UM-5 Klasse ST-1  
200-130-UM-5 Klasse ZN-ZVN  
512-110-UM-5 Klasse ST 565

UM-6



501-135-UM 6  
Klasse ST 2000 / 5000

**Kuris**



02 257

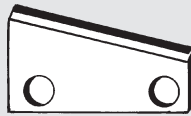

22 219 (CT)

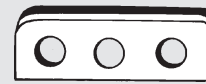

31 391 (CT)



25 208 (CT)  
Suprena M 460 / 706



30 785 (CT)  
Suprena M 456, M 458



Für alle Bandmesser-Zuschneidemaschinen  
z.B. Kuris, Hoogs, Bullmer, Wastema, Hitaka,  
CKS, NCA, Takaoka usw.  
10–20 mm breit,  
0,45 mm stark,  
in verschiedenen Schliffarten  
(siehe unten).

For all band knife cutting machines, e.g.  
Kuris, Hoogs, Bullmer, Wastema, Hitaka,  
CKS, NCA, Takaoka etc.  
10–20 mm wide  
0,45 mm thick  
in various grinding versions  
(see below).

Para todas las máquinas cortadoras  
de cuchilla cinta p.e. Kuris, Hoogs, Bullmer,  
Wastema, Hitaka, CKS, NCA, Takaoka etc.  
Ancho 10–20 mm,  
espesor 0,45 mm  
varios afilados  
(véase abajo).

Hergestellt aus erstklassigem Material,  
lieferbar als Meterware oder in Endloslängen  
(Fixlängen).

Manufactured of first-class material,  
available in metrages or endless length  
(fix length)

Hechas de materiales de primera clase, de  
ser entragadas por metro o en largos conti-  
nuos (largos fijos).

glatt  
smooth  
liso

gezahnt  
serrated  
dentado

gezahnt 2,5 mm  
serrated 2,5 mm  
dentado 2,5 mm

konkav  
concave  
cóncavo

konvex  
convex  
convexo

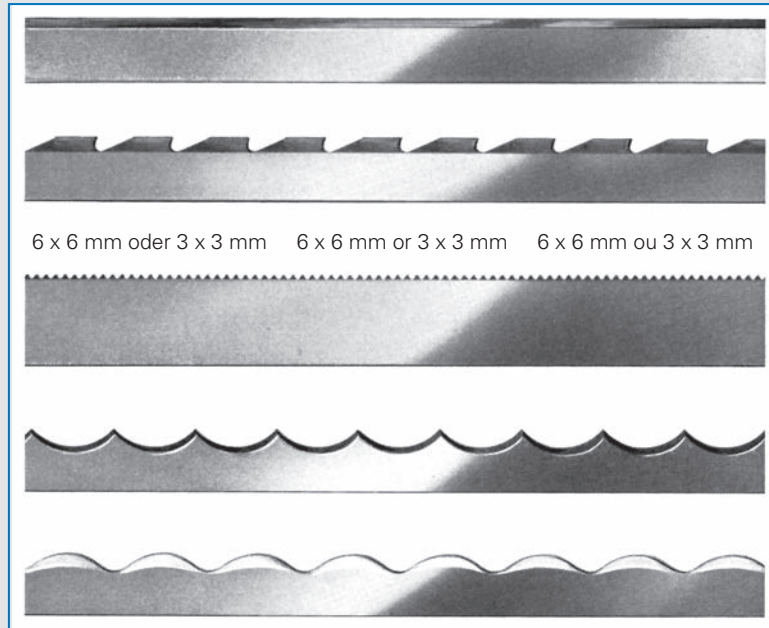

Doppelte Wate  
Double bevel  
Biselado doble



Vierfach Wate  
Four bevels  
Biselado cuádruplo

Gebräuchliche Abmessungen: glatt, doppelte Wate  
Usual dimensions: smooth, double bevel  
Dimensiones en uso: liso, biselado doble

2400 x 10 x 0.45	3605 x 10 x 0.45	4200 x 10 x 0.45	4810 x 10 x 0.45
2430 x 10 x 0.45	3680 x 10 x 0.45	4210 x 10 x 0.45	4850 x 10 x 0.45
2450 x 10 x 0.45	3700 x 10 x 0.45	4210 x 15 x 0.45	4850 x 15 x 0.45
2880 x 10 x 0.45	3720 x 10 x 0.45	4240 x 10 x 0.45	4900 x 10 x 0.45
2900 x 10 x 0.45	3750 x 10 x 0.45	4250 x 10 x 0.45	4920 x 10 x 0.45
2945 x 10 x 0.45	3760 x 10 x 0.45	4350 x 10 x 0.45	4920 x 15 x 0.45
3000 x 10 x 0.45	3840 x 10 x 0.45	4400 x 10 x 0.45	5030 x 10 x 0.45
3050 x 10 x 0.45	3850 x 10 x 0.45	4450 x 10 x 0.45	5050 x 10 x 0.45
3100 x 10 x 0.45	3860 x 10 x 0.45	4460 x 10 x 0.45	5070 x 10 x 0.45
3100 x 15 x 0.45	3870 x 10 x 0.45	4500 x 10 x 0.45	5150 x 10 x 0.45
3120 x 10 x 0.45	3880 x 10 x 0.45	4530 x 10 x 0.45	5200 x 10 x 0.45
3150 x 10 x 0.45	3900 x 10 x 0.45	4550 x 10 x 0.45	5207 x 12 x 0.45
3240 x 10 x 0.45	3900 x 15 x 0.45	4550 x 15 x 0.45	5210 x 10 x 0.45
3300 x 10 x 0.45	3950 x 10 x 0.45	4555 x 10 x 0.45	5230 x 10 x 0.45
3360 x 10 x 0.45	3960 x 10 x 0.45	4560 x 10 x 0.45	5270 x 10 x 0.45
3380 x 10 x 0.45	4020 x 10 x 0.45	4600 x 10 x 0.45	5280 x 10 x 0.45
3400 x 10 x 0.45	4040 x 10 x 0.45	4620 x 10 x 0.45	5285 x 10 x 0.45
3420 x 10 x 0.45	4050 x 10 x 0.45	4650 x 10 x 0.45	5300 x 10 x 0.45
3460 x 10 x 0.45	4080 x 10 x 0.45	4690 x 10 x 0.45	5300 x 12 x 0.45
3470 x 10 x 0.45	4094 x 10 x 0.45	4700 x 10 x 0.45	5300 x 15 x 0.45
3480 x 10 x 0.45	4100 x 10 x 0.45	4745 x 10 x 0.45	5500 x 10 x 0.45
3500 x 10 x 0.45	4100 x 12 x 0.45	4750 x 10 x 0.45	5800 x 15 x 0.45
3530 x 10 x 0.45	4115 x 12 x 0.45	4750 x 12 x 0.45	5840 x 10 x 0.45
3540 x 10 x 0.45	4120 x 10 x 0.45	4750 x 15 x 0.45	6040 x 10 x 0.45
3550 x 10 x 0.45	4130 x 10 x 0.45	4800 x 10 x 0.45	
3600 x 10 x 0.45	4150 x 10 x 0.45	4800 x 15 x 0.45	



## Die Schmirgelschnur ist: Features of the abrasive cord:

- flexibel / flexible
- abriebfest / resistant to abrasion
- verschleißarm / wear resisting
- geruchsneutral / odourless
- bruchfest / break-proof
- gleichmäßig im Durchmesser  
constant diameter

			Abrasive cords Standard Schmirgelschnur Standard cord		Silizium Carbide cords Feinere Struktur finer structure		Polisher cords zum Polieren for polishing		Oxyd Polisher cords zum Feinstpolieren for finest polishing	
Ø mm	Ø Zoll/Inch		Bestell-Nr. Order No.	Körnung Grain	Bestell-Nr. Order No.	Körnung Grain	Bestell-Nr. Order No.	Körnung Grain	Bestell-Nr. Order No.	Körnung Grain
<b>Rollen/Spools 15 m:</b>										
66	0,3	0,012			1SC/15	280	1PC/15	280		
60	0,4	0,015	2AC/15	280	2SC/15	280	2PC/15	280		
55	0,5	0,019	3AC/15	240	3SC/15	240	3PC/15	280	3OX/15	Oxyd
54HS	0,6	0,023	4AC/15	240	4SC/15	240	4PC/15	280	4OX/15	Oxyd
	0,7	0,027	5AC/15	240	5SC/15	240	5PC/15	280	5OX/15	Oxyd
54	0,8	0,031	7AC/15	180	7SC/15	180	7PC/15	280	7OX/15	Oxyd
53	1,0	0,039	8AC/15	180	8SC/15	180	8PC/15	280	8OX/15	Oxyd
	1,2	0,047	12AC/15	150	12SC/15	150	12PC/15	280	12OX/15	Oxyd
52/51	1,4	0,055	14AC/15	150	14SC/15	150	14PC/15	280	14OX/15	Oxyd
50	1,8	0,071	18AC/15	120	18SC/15	120	18PC/15	280	18OX/15	Oxyd
49	2,1	0,082	21AC/15	120	21SC/15	120	21PC/15	280		
<b>Rollen/Spools 50 m: (1,4 und 1,8 mm Ø = 25 m)</b>										
66	0,3	0,012			1SC/50	280				
60	0,4	0,015	2AC/50	280	2SC/50	280	2PC/50	280		
55	0,5	0,019	3AC/50	240	3SC/50	240	3PC/50	280		
54HS	0,6	0,023	4AC/50	240			4PC/50	280		
	0,7	0,027	5AC/50	240			5PC/50	280		
54	0,8	0,031	7AC/50	180	7SC/50	180	7PC/50	280		
53	1,0	0,039	8AC/50	180	8SC/50	180				
	1,2	0,047	12AC/25	150						
52/51	1,4	0,055	14AC/25	150						
50	1,8	0,071								



Teil-Nr. Part No.	Seite Page	Teil-Nr. Part No.	Seite Page	Teil-Nr. Part No.	Seite Page	Teil-Nr. Part No.	Seite Page
00453700	26	0246002408	25	0557001686MS	22	0577350230	21
004538.00	26	0246002553	25	0557002035	22	0577350240	21
004539.00	26	0246350040	25	0557002872	22	0578003281	23
004540.00	26	0246350060	25	0557002872A	22	0578003282	23
0055000602	21	0251GR1705	20	0557002876K	22	0578003283	23
0055000603	21	0251GR2438V2	20	0557003243	22	0578003284	23
0055000606	21	0265008772	19	0557003398	22	0578003285	23
0067004600 HSS	16	0265012265	19	0558002405	22	0578003286	23
0067009360	16	0268330470	15	0558002406	22	0578003287	23
0067330570	16	0268350010	15	0558002408	22	0578003288	23
0067330580	16	0268350030	15	0558002410	22	0578003289	23
0067330700	16	0271001483	19	0558002411	22	0578003290	23
0067351220	16	0271001497	19	0558002552	24	0578003291	23
0067351230	16	0272007042	19	0558002561	22	0578003292	23
0068004600	15	0272007045	19	0558002562	22	0578003293	23
0081000660	15	0272076157	19	0558002564	22	0578003295	23
0081000820	15	0291003002	19	0558002565	22	0578003304	23
0081005820 (CT)	15	0291003004	19	0558002566	22	0578003308	23
0083000660	15	0296200020	20	0558002567	22	0578003309	23
0083000820	15	0296330430 (CT)	20	0558006109	22	0578003311	23
0085168	109	230-05804	39	0558006110	22	0578003314	23
008688.00	26	032419013	132	0558006855	24	0578003315	23
01039999	134	0367210240 HSS	16	0558008816	23	0578003316	23
01040445	134	0367330780 HSS	16	0558008817	23	0578003323	23
0129171853	26	0367331300 HSS	16	0558008858	23	0578003324	23
0129175540	26	0367331310 HSS	16	0558008859	23	0578003363	23
014245	138	0367331320 HSS	16	0558008868	23	0578003365	23
01-4434-01	128	0367331330 HSS	16	0558008869	23	0578003366	23
01-4435-01	128	0367350050	17	0558008878	23	0580330300	24
014694	138	0367350070	17	0558008879	23	0580330370	24
0167004610	16	0367355030	17	0558009011	22	0580330390	24
0167004620	16	0370221570	17	05-658	46	0580330400	24
0167330020 (CT)	16	0380007293	19	0568330760	20	0580350270	24
0167350010	16	0396200090	20	0568330770	20	0580350280	24
0170200190	20	0396330690	20	0568350050	20	0580350970	24
0171003253	17	0396330700	20	0570000961	20	05-812	46
0171004602	18	0396331600	20	0570000962	20	0659350110	24
0173003725	18	0396350750	20	0570000967	20	0697002075 (CT)	18
0195004753	17	0467200220	16	0570092908A	20	07-124 (CT)	45
0195004753A	17	0467350330	17	0570092917A	20	07-168	45
0195005055	17	0477330240	17	0570092921	20	07-169	45
0195005055A	17	0510350060	26	0570092925	20	07-170	45
0195010127	18	0510B2421-280-0A0	26	0576005701	21	07-206	45
0196104017	18	0510B2424-280-000	26	0576005702	21	07-406 (CT)	45
0204001065	18	0540330110	21	0576005703	21	0746000995	25
0211008504	19	0540350290	21	0576005704	21	0746000995A	25
0211009685	18	0540350340	21	0576005705	21	0746000996	25
0212004931 (CT)	18	0540350350	21	0576005706	21	0746000996A	25
0212005058	18	05-429	44	0576005707	21	0746000997	25
0212011368 (CT)	18	0556007143	21	0576005708	21	0746000997A	25
02126109	132	0556007144	21	0576005709	21	0746060689	25
0219003963 (CT)	18	0556007146	21	0576005710	21	0746060690	25
0219006708A	18	0556007148	21	0576005711	21	0746060691	25
02257 HSS	138	0556007149	21	0576005712	21	0746060692	25
0227000682	18	0556007151	21	0576005713	21	0748000419	25
0227000683	18	0556007152	21	0576005722	21	07-505 (CT)	46
0238001417 HSS	19	0556007157	21	0576005723	21	07-507	46
0238001418 HSS	19	0556012772	21	0576005724	21	07-558	46
0238006549	19	0556012783	21	0576005725	21	07-570 (CT)	46
0238016496	19	0556013536	21	0576005726	21	0767350260	17
0244014157	19	0557000593	22	0576005727	21	0767350280	17
0244014161	19	0557000602A	22	0576005728	21	07-702 (CT)	45
0246000595	25	0557000605	22	0576005729	21	07-703 (CT)	45
0246002401	25	0557000611	22	0576005730	21	07-707	45
0246002402	25	0557000614	22	0576005731	21	0793027524	27
0246002405	25	0557001684MS	22	0577350080	21	085878000	132





Teil-Nr. Part No.	Seite Page	Teil-Nr. Part No.	Seite Page	Teil-Nr. Part No.	Seite Page	Teil-Nr. Part No.	Seite Page
0867210430	26	09-009733-37	58	10-1069-0-006 1 1/8-29	75	113-51400	37
0867330270	26	09-009801-40	55	10-1069-0-007 1 1/4-32	75	113-51509	37
0867330280	26	09-009801-41	55	10-1069-0-009 1 1/2-38	75	114-08150	35
0867330430	26	09-009802-00	55	10-1069-0-020 5/8-16	75	114-09257	35
0867330570	26	09-009802-28	58	10-1069-0-021 3/4-19	75	114-09604	35
0887200090	24	09-009802-29	57	10-1069-0-022 7/8-22	75	115-39202	30
0887200150	24	09-009804-51	58	10-1069-0-073 1/2-13	75	115-44806	31
0887330010	24	09-009806-67	56	10-1069-0-074 5/8-16	75	11563	100
09-009048-39	61	09-009806-72	60	10-1069-0-076 7/8-22	75	115-65900 (CT)	29
09-009049-56	57	09-009806-73	59	10-1069-0-077 1-25	75	115-66502	30
09-009050-06 (CT)	55	09-009807-47	58	10-1069-0-079 1 1/4-32	75	115-98406	30
09-009050-62	57	09-009807-78	55	10-1069-0-080 1 3/8-35	75	116802	133
09-009052-54	55	09-009811-92	58	10-1069-0-081 1 1/2-38	75	116-81301	31
09-009052-55	55	09-009812-96	58	101572-0-12	86	118-29405	32
09-009052-56	55	09-009812-97	56	102-11209	36	11837	100
09-009053-31	56	09-009819-09	55	102-11605	36	11837	127
09-009053-33	56	09-009825-62	56	10-2206-1-000	75	118-45609 (CT)	29
09-009053-33	62	09-009825-63	62	10-2207-1-000	75	118-45708 (CT)	29
09-009054-19	56	09-009825-64	62	10-2207-1-600	75	118-45906	107
09-009054-20	57	09-009826-26	62	102642	132	118-45906 (CT)	29
09-009054-43	55	09-009826-28	62	10-3072-0-014	75	118-46003	30
09-009065-26	57	09-009831-32	56	10-3072-0-023 1 1/4 NE	75	118-47407	29
09-009065-29	55	09-009831-32	62	10-3072-0-024 C72-RJRE 1 1/4	75	118-47506	29
09-009065-89	57	09-009833-45	58	75		118527-001	11
09-009065-90	56	09-009842-89	56	10-3072-0-059 5/8 CT-RE	75	118-88005	31
09-009066-42	55	09-009844-22	59	10-3072-0-060 3/4 CT-RE	75	118-88104	31
09-009067-68	57	09-009846-02	55	10-3072-0-067 5/8 CT-LE	75	118-88203	31
09-009067-69	57	09-009846-08	56	103630	132	118-88302	31
09-009067-70	56	09-009846-09	59	103986	132	118-88401	31
09-009068-07	56	09-009846-10	59	10-4005	75	118-88500	31
09-009068-97	60	09-009846-11	59	10-4006-0-000	75	118-88501	31
09-009068-98	57	09-009846-12	59	10-4007-0-000	75	118-88609	31
09-009070-82	55	09-009846-13	59	10-4009	75	118-88708	31
09-009071-09	55	09-009846-14	59	104264	132	118-89904	32
09-009071-19	60	09-009846-15	59	104450	132	118-97501	30
09-009071-27	60	09-009846-17	59	105934	132	119202	65
09-009603-48	56	09-009846-18	59	105935	132	119202/4,3	65
09-009603-49	57	09-009846-19	59	106-46909	34	119202/4,3	65
09-009606-90	56	09-009846-20	59	106-50703	34	119202 HSS	65
09-009611-28	58	09-009852-26	63	107-26305	36	119444	65
09-009611-29	58	09-009852-27	63	107-26404	36	119444/4,3	65
09-009611-68	60	09-009852-28	63	107506-T	134	119444/4,3	65
09-009611-70	60	09-009854-48	62	107519	94	119444 HSS	65
09-009615-99	57	09-009854-49	63	107797	91	119-91908	31
09-009616-01	58	09-009854-52	63	1100880	132	119-93607	31
09-009616-03	58	09-009854-53	63	110121-001	4	119-99208	31
09-009616-04	58	09-009854-54	63	110121-001	127	119-99307	32
09-009616-58	61	09-009854+55	63	110-40052	35	119-99802	32
09-009616-98	60	09-009857-11	55	110736-001	12	120-03604	32
09-009617-06	58	0933000337A	17	110737-001	12	120-04909 (CT)	30
09-009617-07	58	0933005712	18	110-93259	35	120-14908	31
09-009617-26	60	0933063983	18	11111	110	121-20705	32
09-009617-33	61	0939017104	18	1112	85	121-76004	31
09-009617-97	58	0939017504	18	1113	85	121-76103	31
09-009617-98	58	09-400401-00	49	11165x2.7	65	121-76202	31
09-009618-08	58	09-400401-00	62	11165x3.0	65	122-20307	30
09-009618-12	57	09-400404-00	62	11165x3.5 HSS	65	122-20307	107
09-009620-31	58	09-400427-00	62	11179x2.7	65	122-40107	32
09-009620-33	58	0971440140	27	11179x2.7 HSS	65	122-40107	107
09-009620-34	58	0971440180	27	11179x3.5	65	122-47508	31
09-009620-39	56	100124	132	11233x2.7 HSS	65	122-47508	107
09-009620-45	60	10-1069-0-001 1/2-13	75	112436-001	11	123-83501	31
09-009620-66	61	10-1069-0-002 5/8-16	75	113-13053	35	123-83600	31
09-009621-65	59	10-1069-0-003 3/4-19	75	11324x2.7	65	123-84202	32
09-009732-15	55	10-1069-0-004 7/8-22	75	11324x3.5	65	123-84400	32
09-009733-31	58	10-1069-0-005 1-25	75	11324x3.5 HSS	65	124-45508 (CT)	30



Teil-Nr. Part No.	Seite Page	Teil-Nr. Part No.	Seite Page	Teil-Nr. Part No.	Seite Page	Teil-Nr. Part No.	Seite Page
124-47504	30	146612-001	12	1662	116	20-0051-0-003	74
124-81008	31	146635-001	12	1662 A	116	20-0051-1-024	74
124-81107	31	146792-001	12	167 L	110	20-0051-1-024	74
124-81800	32	146962-001	12	168 R	110	20-0051-1-024	74
124-82600	32	147211	91	169	110	20-0094-0-000	74
1250004-229B	100	147934-001	12	17-0004-9-894	76	20-0094-1-000	74
1250004-237B	100	147936-001	12	17-0004-9-895	76	20-0111-0-000	74
127260-001	5	147937-001	12	17-0064-5-849	76	20-0112-0-000	74
127814-001	5	148198-001	11	17-0064-5-852	76	20-0116-3-000	74
129-40508	38	148815-001 (CT)	11	17-0064-5-854	76	20-0119-2-000	74
129-40557	38	148869-001	5	17-0064-5-855	76	200-130-UM-5	138
129-40953	38	148870-001	5	17-0064-5-856	76	200271-0-10	85
129-41050	38	148871-001	5	17-0064-5-858	76	200274-0-10	85
129-41407	38	15111-A	100	17-0064-5-864(CA)	76	20-0356-0-003 ED	74
129-41456	38	152901-001	2	17-0064-5-950(CB)	76	200403-0-10	85
129-41555	38	152905-001	2	17-0069-4-019	76	2008 K (UX)	101
129-41852	38	152906-001	2	17-0069-4-048	76	2008 Q (UXA)	101
129-41951	38	153019-001	4	17-0069-4-049	76	201085 B	57
129-68509 (L)	38	15408 A	113	17-0087-0-204	76	201121 A (CT)	55
129-68558	38	15408 G	113	175085	91	201127	55
129-68657	38	154176-001	2	175547	91	201234 A	57
129-68806 (R)	38	15449	113	179458-05 (CT)	59	202092-0-11	81
129-68855	38	154568-001	3	179459-05 (CT)	60	202094-0-13	82
129-68954	38	154575-001	3	180614 DKP	20	202095-0-13	82
129-69101 (C)	38	15460	113	181812000 HSS	54	202142-0-10	79
129-69150	38	15470	113	181814003	54	202145-0-10	79
129-79209	38	154851000	54	1840096	99	202146-0-11	79
129-79308 (C)	38	154852000	54	1840097	99	202148-0-10	84
131-50503 (CT)	30	15487	28	186188202 (CT)	54	202295	55
131-50602 (CT)	30	15487 Ceramic	120	1870004	99	20241-11.0	54
131-50701	30	1-550449-000	131	1870047	99	20241-14.0	54
133-37902	37	155193-001	11	1870053	99	20241-17.5	54
134-24809	37	155240-001	12	1870053	127	20241-20.0	54
137562	61	155241-001	12	188004	61	202413-0-13	82
138-81255	35	159365-001	4	19-0064-5-855	76	20241-33.3	54
140242-001 (CT)	11	159434-001(F)	12	19-0087-0-434	76	20241-36.5	54
140-30803	42	159540-001	3	19-351	44	20241-39.7	54
140-30902	42	159541-001	3	19-351	46	202504-0-10	84
140-31009	42	159686-001	12	19-353	44	202527 (CT)	55
140-31017	42	159799-001	3	19-431	44	202570	55
140-31108	42	159915-001	3	19-437	44	202571	55
140-31116	42	164026	91	19-505	46	202572	55
140-41206	42	164037	91	19-505	46	202703	57
140 567-001	11	164045	92	19-512	44	20271	121
14-1197-1-000	75	164-16109	39	19-514	44	202828 (4)	56
1-412749-000	131	164-18006	39	19-518	44	202874 (1)	56
14136	121	164-18600	39	19-521	44	202893 (CT)	55
141541-001	7	164-18709	39	19-522	44	203005-0-10	82
141543-001	7	164252	92	19-525	46	203010-0-10	79
142032	91	164308	91	19-531	44	203012-0-10	80
142058-001	4	164375	92	19-535	44	203066-0-10	79
142061-001	4	164550	91	19-536	44	203755-0-10	82
143734-001	12	164556	91	19-539	46	203759-0-10	80
14-4004-0-000	75	164619	92	19-546	44	20378	122
14-4005-0-000	75	164728	91	19-547	44	203783-0-10	80
14-4005-0-030	75	164809 (CT)	91	19-548	44	204021-0-10	81
14-4008-1-000	75	164813 (CT)	91	19-549	44	204022-0-10	81
14-4009-1-000	75	1650004-229 (CT)	100	19-581	44	204033-0-10	81
144042-001	12	1655	116	19-582	44	204062 (2)	56
144049-001	12	1657	116	19-583	44	204072	57
144074-001	13	166-07301	39	19-703-0	45	204152	55
144074-001 (CT)	11	166-07400	39	19-712	45	204161	56
144074-200	13	166-07509	39	19-713	45	204161	62
144074-300	13	166-07608	39	19-801	46	204161A	56
144077-001	11	16607707	39	19-807	46	204161A	62
146042-001	12	166-07806	39	19-814	46	204351 (CT)	56



Teil-Nr. Part No.	Seite Page	Teil-Nr. Part No.	Seite Page	Teil-Nr. Part No.	Seite Page	Teil-Nr. Part No.	Seite Page
204431	57	209352-0-10	80	2111417-556-B	100	23-2356-2-999 1 1/2	74
204663 (7)	56	209353-2-00	80	211168	57	233934	89
204676-0-11	82	209354-0-10	80	2112	85	235-06009	41
204693-0-11	80	209355-2-00	80	211248-0-00	82	236101	63
204693-0-11BAK	80	209357-2-00	79	211249-0-00	82	236500	63
204695-0-11	84	209358-0-10	79	211266-0-00	82	236500 A	63
204702 (4)	56	209425-2-01 (CT)	80	211267-0-00	82	236501 A	63
204703 (6)	57	209593-0-00	79	211424-2-00 (CT)	81	236502 A	63
204704 (3)	57	209685	61	211651	57	236503 A	63
204705 (5)	57	2100167	121	211662 (CT)	55	236504 A	63
204809-0-00	84	2101091	121	211662A (CT)	55	236606 SUPER	63
204835 (CT)	55	2101155 (CT)	121	211719 (38)	58	236608 SUPER	63
204907	60	2101156 (CT)	121	211742	56	236618	63
204949 (11)	58	210354	57	211771 (CT)	55	238508	89
20496 (CT)	121	210356	57	211788	56	238508 HSS	89
204963 (8)	58	210357	58	211845 (29)	58	238543	89
204964 (9)	58	210358 (2)	58	2119301 (Y1)	123	238546	89
20498	121	210359 (4)	58	2119302 (Y2)	123	238548	89
204990 (12)	56	210360 (6)	58	2119303	123	239367	92
204991	57	210364 (22)	58	2119305	123	239372	92
205151-0-00	80	210365 (24)	58	2119322 (F3)	123	239715	94
205607 (CT)	55	210366 (26)	58	2119324	123	241574 HSS	89
205609	55	210367 (28)	58	212092 (10)	58	24306	133
20577	122	210445	61	2121107 (CT)	121	249191-3.1	89
205890 (CT)	55	210494	60	2121111	121	249191 HSS	89
205-9101-01A	43	2105	101	212215	58	2500895.00	26
205-9101-01A	131	210512 (21)	58	2126	101	25046	122
205-9102-01A (CT)	43	210513 (23)	58	212644	58	25208 CT	138
205-9102-01A (CT)	131	210568	60	2129300	123	254-43805	39
206048-0-13	82	210575	61	21-3002 (CT)	28	254-46808	39
206512-0-02	81	210729 (30)	58	21-3003	28	257550-91	49
207000-2-00 (CT)	79	210730 (32)	58	21-3004	28	257550-91	62
207001-2-00 (CT)	80	210762	56	213105	58	257552	62
207002-2-00 (CT)	79	210787	60	213108	56	257555	62
207003-2-00 (CT)	80	2108	101	213-89200	36	257565	62
207004-2-00 (CT)	80	2108 G	101	213-89309	36	257566	62
207006-2-00 (CT)	79	210810	61	21-4001	28	257573	62
207011-0-00	79	2108 A	101	21410042-29	130	257573	62
207015-2-00 (CT)	79	2108 B	101	21410042-37	130	257573A	62
207016-2-00 (CT)	80	2109300	122	21-4587	28	257573A	62
207017-2-00 (CT)	79	2109301	122	2149 (AB)	101	257574	62
207020-2-01 (CT)	80	2109302	122	21-5602	28	257574	62
207208-0-10	82	2109304	122	2170 (AA)	101	263735	89
207722-0-01	82	2109305	122	21700	122	268310	93
207995-0-00	82	2109307	122	21701	122	268369	94
208011-0-01	81	2109308	122	21754	122	268380	93
208063	60	2109309	122	21756	122	268382	93
208215	60	2109310	122	21757	122	27277-074	81
208336	60	2109320	122	22219 CT	138	27277-0745	81
208338	60	2109322	122	225-57557	41	270-075	82
208393	56	2109324	122	225-57706	41	270-075/2	82
209223-0-00	81	2109326	122	226-55302	36	270-0751	82
209247-0-00	81	2109328	122	2273110120	47	270-113	79
209248-0-00	81	2109331	122	230-05903	39	270-113/1	79
209249-0-00	81	2109334	123	23-2356-2-049 1/4	74	270-114	84
209261-0-00	82	2109335	123	23-2356-2-050 3/8	74	270-1141	84
209264-0-00	82	2109341	122	23-2356-2-051 7/16	74	27012	122
209265-0-00	82	2109343	122	23-2356-2-052 1/2	74	27013	122
209267-0-00	82	2109347	123	23-2356-2-053 9/16	74	270616	94
209340-2-10 (CT)	80	2109348	122	23-2356-2-054 5/8	74	270619	94
209341-0-10	80	2110305	121	23-2356-2-055 3/4	74	270-D-074/1	81
209342-2-10 (CT)	80	2111	101	23-2356-2-056 7/8	74	271926	90
209347-0-10	79	2111055 (CT)	121	23-2356-2-057 1	74	27264	129
209348-0-10	79	2111056 (CT)	121	23-2356-2-058 1 1/8	74	276489	91
209350-0-10	79	2111407-553-B	100	23-2356-2-059 1 1/4	74	277000 (CT)	55
209351-2-00	80	2111417-553-A	100	23-2356-2-060 1 3/8	74	277009	56



Teil-Nr. Part No.	Seite Page	Teil-Nr. Part No.	Seite Page	Teil-Nr. Part No.	Seite Page	Teil-Nr. Part No.	Seite Page
277010 (2)	59	3101465 (CT)	124	34113	118	36 C 22-1	127
277010 A (5)	59	3101607	124	3430-22	127	373537	94
277010 B	59	3101633	124	34392	118	373539	94
277011 (3)	59	3101699	125	34393	118	37514	119
277012	59	3101700	125	344559	47	37538	119
277013	59	3101801	125	344559	95	377443	47
277014 (1)	59	3101802	125	34519	118	377443	95
277014 A (8)	59	3109300	125	34584	118	377462	47
277014 B (9)	59	3109306	125	34599	118	377462	95
277015	59	3109310	125	34709 (UR)	102	377465	47
277015 A	59	3110037 (CT)	124	34709 (UR)	108	377465	95
277016 A	59	3110038	124	34709 D (URD)	102	377559	47
277017 (11)	59	311-54503	33	34709 D (URD)	108	377559	95
277018	59	311-54602	33	34730	118	377560	47
277018 C	59	3120016	125	34749	102	377560	95
277019 (12)	59	3120151	124	34749 EL	108	377600	47
277021	58	312057-0-00	85	34749 K	102	377600	95
277034	59	312-800-026	116	34749 M	108	377601	47
277-074	82	312-870-001	116	34749 M	102	377601	95
277-113/277-113	80	312-870-002	116	34749 M	108	377602	47
279-112	79	312-870-003	116	34770 M	108	377602	95
281208	93	312-870-004	116	34770 EL	108	377638	47
290-075/2	82	313-801-025	117	34770 K	102	377638	95
290-113 SP	80	313-801-036	117	34770 K	108	377639	47
290-114/1	84	313-810-001	117	34770 M	102	377639	95
29-924990-88	130	313-810-010	117	350018-91	62	377640	47
29-924992-56/100	130	313-810-012	117	350018-91	62	377640	95
29-924993-56	130	313-870-002	117	350024	62	377641	47
29-924993-70/299	130	313-870-003	117	350024	62	377641	95
29-924993-70/641	130	313-870-005	117	350069-0-00	88	377740	47
29-924993-70/876	130	313-870-015	117	3501026	125	377740	95
29-924993-71/442	130	31391 CT	138	3501032 (CT)	124	38332	119
29-924993-81/668	130	315507-0-00	85	350107-0-00	88	39160	108
29-924993-81/704	130	315805-0-00	86	350145-2-11	88	39208 AA	108
29-924993-81/957	130	315863-2-02	86	3501534	124	39208 B	108
3008 Q	101	318735-0-00	86	3501535 (CT)	124	39224 AA	108
301008 (CT)	59	31877	118	3501597 (CT)	124	39224 AC 3/32	108
301035 (CT)	60	318791-2-00 (CT)	86	350183-0-00	88	39224 AC 1/8	108
301036 (CT)	59	318792-2-00 (CT)	86	350218	62	39224 J	108
3018	116	318794-2-00 (CT)	86	350220	62	39249	108
302057-0-13	85	3201062	124	350452-0-00	88	39249 A	108
3021092	120	320-18012	42	350453-0-00	88	39249 K	108
302807-0-10	85	320-20505	42	351161-0-10	88	39270 A	108
302808-0-10	85	320-23319	42	351163-0-10	88	39270 D	108
303012-0-10	85	320-40800	42	35227	118	39270 E	108
303419-0-12	85	320-40917	42	35285	119	39505 B	106
30421	119	3209311	125	3543 HSS	116	39508 A (CC)	104
305248	43	321128-0-10	86	3544 A HSS	116	39508 B	104
305248	131	321164-0-00	86	35796 B	101	39508 C	104
305249	43	32-2019-1-000	77	35796 C	101	39508 D	104
305249	131	32-2047-1-001	78	35808 AY (AU)	101	39508 E (CK)	104
306224-0-10	87	32-2047-1-002	78	35809 AY (AV)	101	39508 P	104
306283-2-00 (CT)	87	32-2048-1-001	78	35809 BY (AY)	101	39524 AB 1/8	104
306284-2-00 (CT)	87	32-2048-1-002	78	36-16	113	39524 AB 5/32	104
306285-2-00 (CT)	87	32539	118	36-16	127	39524 B 3/32 (V 3/32)	105
306286-2-00 (CT)	87	32541	118	36-19	113	39524 B 1/8 (V 1/8)	105
306394 (CT)	62	32807	118	36208 A	102	39524 B 5/32 (BH)	105
30785 CT	138	32813	118	36-21	113	39524 C 1/8 (AC 1/8)	105
308026-91 (CT)	59	32820	89	36210	102	39524 C 5/32 (AC 5/32)	105
308030 (CT)	59	32823	89	36240 (D)	102	39524 AB 1/8 ohne Transp.schl.	104
308142-0-00	86	32824	89	36250 SUPER	102	39524 AS (BE)	106
3100512	124	32914 (CT)	119	36251 E (A)	102	39524 BF 1/8 (BK)	106
3100513	124	33059	118	36251 F	102	39524 D (AM)	106
3100708	124	330 ACAR (CT)	129	36251 FD	102	39524 J	106
3101026	124	33709 C	101	36251 W	102	39524 N (AH)	106
3101028 (CT)	124	33821	119	36270 SUPER	102	39524 P (AJ)	105



Teil-Nr. Part No.	Seite Page	Teil-Nr. Part No.	Seite Page	Teil-Nr. Part No.	Seite Page	Teil-Nr. Part No.	Seite Page
39524 W (AN)	105	4284	120	52970 D (CT)	111	68560	120
39526 AW	106	4301119	119	52970 E	111	68 668-3.1	15
39526 B	106	4301125	119	53407	110	69084	120
39549	103	441031 (CT)	117	53409	110	69085	120
39549BAK	103	442001	117	5350	116	69086	120
39549 J	103	46-1001-4-136	77	540741	94	6-91	51
39549 SC	103	46-1001-5-289	77	540760	94	6-91 C	51
39556 K	103	46-1001-5-487 Ceramic	77	54208 (BZ)	110	6-91 E	51
39556 L	103	46-1004-9-073	77	54208 A (CB)	110	6-91 K	51
39560 A (E)	104	46-1125-5-000	77	54208 B	110	7000010071	14
39560 B	104	46-1125-5-581	78	54211 A	110	7000020071	14
39570	103	47968	133	544599	93	7000030071	14
39570 J	103	48-1125-5-594 (CT)	77	548205	93	7000040093	14
39570 K	103	48-1125-5-721	78	548207	93	700-00405	32
39570 L	103	501-135-UM-6	138	548231	93	700-00473	30
39570 SC	103	501-138-UM-5	138	548232	93	7000050071	14
39608	90	50143403 (CT)	131	548762	93	7000070071	14
39609	90	50145403	131	548763	93	7000070093	14
39808 (CY)	107	5020101584	131	548764	93	700-00798	31
39808 D (ACZ)	107	5020101604	131	548765	93	700-00799	31
39860 (H)	107	510 S	128	548766	93	7000080071	14
39867	90	51108 DA	113	548767	93	7000080093	14
39870	107	512035	28	548768	93	71 1/8 HSS	90
400-00324	35	512018	28	548769	93	71 1/4 HSS	90
40-0012-2-045 HSS	77	51249 B	109	548770	93	71 5/16 HSS	90
400-04255	40	51270 S	109	548771	93	71 3/8 HSS	90
40-0057-6-000	77	514	128	548886	93	71 7/16 HSS	90
40-0058-5-000	77	51408-12	112	548935	93	71 1/2 HSS	90
400-12403	36	51408-16	112	548936	93	71 9/16 HSS	90
400-12404	36	51409	112	55458	92	71 5/8 HSS	90
40-0127-2-000	77	51449	112	55459	92	71 11/16 HSS	90
400-15684	42	51470	112	5730 3/32	91	71 3/4 HSS	90
400-15685	42	51508M-18	112	57770 A (D)	109	71 13/16 HSS	90
400-15693	42	51708	109	57949	109	71 7/8 HSS	90
400-15694	42	51709	109	59	51	71 15/16 HSS	90
400-15996	42	51908 B-8	112	6031218P700	47	71 1 HSS	90
40035	90	51908 B-9	112	6031218P700	95	71 1 1/16 HSS	90
40048	90	51909 C	112	6031314C500	47	71 1 1/8 HSS	90
400-89755	35	51909 D-9	112	6031314C500	95	71 1 3/16 HSS	90
405-9102-01A	43	520002	28	604	102	71 1 1/4 HSS	90
405-9102-01A	131	520018	28	60507 (CT)	43	71 1 3/8 HSS	90
408-9101-01B	43	520087	28	60507 (CT)	131	71 1 1/2 HSS	90
408-9101-01B	131	522-080-645864	76	60544	43	714-6101-01A	43
408-9102-01A	43	522-080-645950	76	60544	131	714-6101-01A	131
408-9102-01A	131	522-080-694048	76	6200022	121	71-90 1/8 HSS	90
410262	89	522-080-694049	76	6200097	121	71-90 1/4 HSS	90
410295	89	52-275	45	6209300	122	71-90 5/16 HSS	90
410434	89	52-288	45	6209301	123	71-90 3/8 HSS	90
410452	89	522-980-049894	76	63.78-112	85	71-90 7/16 HSS	90
412553	89	522-980-049895	76	63.78-113	85	71-90 1/2 HSS	90
412585	131	525 W	128	633-075/2	85	71-90 9/16 HSS	90
412585 (CT)	89	527013	28	6507044	28	71-90 5/8 HSS	90
41308 BX	109	52708 B	108	66601	119	71-90 11/16 HSS	90
41309 A	109	52708 B	111	67-2047-1-001	78	71-90 3/4 HSS	90
414029	94	52749 A	109	67-2047-1-002	78	71-90 13/16 HSS	90
414030	94	52770 C (B)	109	67-2048-1-001	78	71-90 7/8 HSS	90
4156597-01	130	52770 D (E)	109	67-2048-1-002	78	71-90 15/16 HSS	90
4156628-01	130	52808 E	111	68-0050-0-012	78	71-90 1 HSS	90
418-6101-02A	43	52845 A (B)	111	68-0052-0-012	78	71-90 1 1/8 HSS	90
418-6101-02A	131	52924 BH 5-8	111	68121 SUPER	120	71-90 1 1/4 HSS	90
42-0012-0-000 HSS	77	52928 A 16-8	111	68123	120	72	51
42072	90	52945 M (F)	111	68124	120	75449	113
42220	90	52949	111	68184 SUPER	120	75449 LA	113
42239	90	52949 A	111	68217	120	75449 LA	113
42305	90	52949 B	112	68218	120	75449 LB	113
42309	90	52970 C	111	68 462	15	75470 LA	113



Teil-Nr. Part No.	Seite Page	Teil-Nr. Part No.	Seite Page	Teil-Nr. Part No.	Seite Page	Teil-Nr. Part No.	Seite Page
77015050	15	91-020241-11.0	73	91-166701-04/004 x7	67	96-700565-05	48
785780-001	92	91-020241-12.7	73	91-166701-04/005 x9	67	96-700591-05 HSS	48
80205	115	91-020241-14.0	73	91-166701-04/006 x12	67	96-701080-05	48
80224	115	91-020241-16.0	73	91-167350-01 (CT)	68	96-702414-05	49
80413	120	91-020241-17.5	73	91-167973-05	68	96-702417-91	48
80413	127	91-020241-19.0	73	91-168498-15	68	96-702684-05	49
8061 A-3.1	89	91-020241-20.0	73	91-168499-05	68	96-702692-05	49
81071401	1	91-020241-22.2	73	91-169239x0.8	70	96-702693-05	49
81071415	1	91-020241-25.4	73	91-169239x1.0	70	96-702750-05	48
81071606	1	91-020241-28.6	73	91-169395x5.0 HSS	69	96-705142-05	48
81071609	1	91-020241-31.7	73	91-169395x7.0 HSS	69	96-705205-05	49
81071614	1	91-020241-33.3	73	91-169395x9.0 HSS	69	96-705438-05	49
81073034	1	91-020241-36.5	73	91-170440-05	69	96-705468-05	49
81073087	1	91-020241-38.1	73	91-170560-04/002	69	96-706135-05	49
81073371	1	91-020241-39.7	73	91-170560-04/003	69	96-706509-05	48
81074018 (CT)	1	91-022096-05	70	91-171853-15/000	70	96-706651-05	49
81077009 (CT)	1	91-048908-10-30	64	91-172071-05	66	96-707786-05	49
81208	114	91-048909-93/001 (CT)	64	91-172358-05	66	96-710414-05	48
81224 AB	115	91-054896-05	66	91-172802-01	68	96-712082-05	48
81305 A	115	91-065546-05	70	91-173197-15	66	96-720392-05	50
81308 B	114	91-069595x5.0 HSS	69	91-173792-05x7.0	68	96-720742-05	50
81308 C	114	91-069595x7.0 HSS	69	91-173792-05x9.0	68	96-720744-05	50
81310	114	91-069595x9.0 HSS	69	91-175540-05	66	96-720745-05	50
81311 B	114	91-069596x7.0 (CT)	69	91-175952-05	65	96-722166-05	48
81324 A	115	91-069596x9.0 (CT)	69	91-176094-05	67	96-722820-05	48
81326	114	91-110482-05	68	91-176098-05	67	96-795104-00	49
81507	114	91-113460-05	64	91-176357-05	67	96-795104-00	127
81508	114	91-119202-04/001	65	91-177919-05	68	98-784045-02/000	130
81511	114	91-119202-04/011	65	91-178926-05	68	98-788013-00/900	130
81700300	133	91-119283-01	66	91-179421-01	55	99-134505-05	72
82264	91	91-119444-04/001	65	91-180295-05	68	99-134505-05 HSS	72
85168	120	91-119444-04/011	65	91-181729-05	71	99-134505-05 TIN	72
91-010192-05	64	91-119455-05	66	91-182344-05	70	9949 AR	110
91-011165-04/001	65	91-119486-91	66	91-186659-05	67	996448000	54
91-011165-04/002	65	91-119714-05	65	91-186661-05	67	996449000	54
91-011165-04/013	65	91-119715-05	65	91-189140-05	69	996450000	54
91-011179-04/001	65	91-120748-6.4	73	91-262184-05	70	996451000	54
91-011179-04/003	65	91-120748-9.5	73	91-264240-05	70	996452000	54
91-011179-04/011	65	91-120748-11	73	91-264338-15	70	996453000	54
91-011233-04/011	65	91-120748-12.7	73	91-265118-05	69	996454000	54
91-011324-04/001	65	91-120748-14.0	73	920780-0-10	79	996455000	54
91-011324-04/003	65	91-120748-16.0	73	923918-0-01	83	996456000	54
91-011324-04/013	65	91-120748-17.5	73	923919-0-01	83	996458000	54
91-011957-15	66	91-120748-19.0	73	924638-0-10	87	99669 (GC)	104
91-014046-05	66	91-120748-22.2	73	924670-0-20	87	99669 K (GM)	104
91-015320-2.0	64	91-120748-25.4	73	926752-4-00	83	99670 (GD)	104
91-015320-2.5	64	91-120748-28.6	73	926753-2-01 (CT)	83	99670 L	104
91-015320-3.0	64	91-130182-05	70	926756-2-01 (CT)	83	999-302N1033	102
91-015320-3.5	64	91-130183-05	70	926757-4-01	83	A 9953 1/8 (HV 1/8)	105
91-015320-4.0	64	91-132168-05	70	926758-0-01	83	A10469	102
91-015320-4.5	64	91-132558-05	68	92831000	134	A10470	102
91-015320-5.0	64	91-150166-05 (CT)	68	928531-2-00 (CT)	83	A 2511-202-000	34
91-015323	64	91-150526-04/001	66	928533-4-01	83	A 2512-102-000	34
91-015435x4.0	64	91-150739-24/001	66	933186-0-00	87	A 2512-103-000	34
91-015435x5.0	64	91-150868-24/002	66	933201-0-00	87	A 4113-102-000	34
91-015435x7.0	64	91-164672-91	66	93-415504-49	130	A 4142-335-000 (CT)	34
91-015435x9.0	64	91-164673-01	66	94417 (CT)	123	A 4145-335-000	34
91-018147-05	66	91-164754-05	65	944422-0-00	87	A8375	114
91-019506x5.0	64	91-164925-05	67	94480	123	A8376	114
91-019506x7.0	64	91-165505-05	66	95174	123	A 8377	115
91-019506x9.0	64	91-165505-05	70	95276 (CT)	123	A 90-3	51
91-019737x5.0	64	91-165629-05	69	95276 (CT)	124	A 9392 (CT)	103
91-019737x7.0	64	91-165642-15	70	95277	123	A 9464	111
91-019737x9.0	64	91-166700-04/001 x7	67	95399	123	A 9540	112
91-020241- 6.4	73	91-166700-04/002 x9	67	95499	123	A 9608 B (HG)	106
91-020241- 9.5	73	91-166700-04/003 x12	67	96-700535-05 HSS	48	AH37E	48



Teil-Nr. Part No.	Seite Page	Teil-Nr. Part No.	Seite Page	Teil-Nr. Part No.	Seite Page	Teil-Nr. Part No.	Seite Page
AP37B	48	B 2702-047-S00 1 1/4	40	CT39549 J	104	G 39549 SU (CT)	103
AS26XA	114	B 2702-047-V00 9/16	40	CT39570 J	103	G 39570	103
AT0202000000 (CT)	129	B 2745-771-F00 1/4	40	CT39849	107	G 39570 A	103
AT0204000000	129	B 2745-771-H00 9/16	40	CT42305	90	G 39570 JU	103
B 2126-481-0A0	36	B 2745-771-K00 3/8	40	CT42309	90	G 51409 C	112
B 2421-280-0A0	35	B 2745-771-L00 1/2	40	CT51449	112	G 52928 A 5-8	111
B 2424-280-000	35	B 2745-771-M00 5/8	40	CT52970 C	111	G 53170 R	110
B 4401-03A-0Y	43	B 2745-771-N00 3/4	40	CT68121	120	G6050113C500	47
B 4401-03A-0Y	131	B 2745-771-P00 7/8	40	CT68184	120	G6050113C500	95
B 4401-04A-0Y	43	B 2745-771-Q00 1	40	CT6-90D	51	G6050114P700	47
B 4401-04A-0Y	131	B 4108-352-00D (CT)	34	CT6-91E	51	G6050114P700	95
B 4471-02A-0Y	43	B 4108-352-00D (CT)	34	CT700535	48	G93	132
B 4471-02A-0Y	131	B 4111-804-000	29	CT700591	48	GA 39524 C 1/8 (HB)	105
B 4471-03A-0Y	43	B 4111-804-00A (CT)	29	CT705142	48	GA 39524 C 5/32 (HC)	105
B 4471-03A-0Y	131	B 4111-804-00C (CT)	29	CT82264	91	GA 39524 AW (HH) 5/32	105
B 1109-180-000	41	B 4111-804-00D	29	CT971440140	27	GB 39524 AW (HN)	105
B 1239-372-000	41	B 4111-804-00E (CT)	29	CT971440180	27	GP 1-71	14
B1830-111-000	41	B 4118-804-000	29	CTB 2424-280-000	35	GP 2-71	14
B 2001-771-0A0	40	B 4118-804-00C	29	CTB 4118-804-000	29	GP 3-4-71	14
B 2011-357-000	34	B 4121-052-A00	37	CTD 110-10	117	GP 4-93	14
B 2030-380-000	37	B 4121-522-000	37	CTD 110-8 A	117	GP 5-71	14
B 2030-481-000	36	B 4122-352-00A	34	CTD 119-10	117	GP 7-71	14
B 2031-380-000	37	B 4145-530-B00	37	CTD 119-7	117	GP 7-93	14
B 2118-816-000	30	CAM 315	50	CT Diamant FR	128	GP 8-71	14
B 2401-180-000	41	CAM 316	50	CTG 39570	103	GP 8-93	14
B 2402-180-000	41	CB 28	98	CTMS03A0838	53	GU 3605	94
B 2406-373-0A0	41	CHG37	48	CTS20582-001	13	GU 3606	94
B 2406-761-0A0	40	CRL103	97	CV 2	133	GUL604152	47
B 2406-771-0A0	40	CS 37	48	D 2402-415-BA0	35	GUL604152	95
B 2408-761-000	40	CS 816	48	D 2402-555-BA0	35	HE 22	97
B 2408-771-000	40	CT03670210240	16	D 2406-555-B00	35	HZ3B	134
B 2410-373-000	41	CT11109	110	D 2406-555-D0H	35	HZ5K.S	134
B2421-205-0A0	35	CT11110	110	D 110-10	117	J101.10.1-2	71
B 2421-210-000	35	CT11111	110	D 110-8 A	117	J101.10.1-7	71
B2421-210-AA0	35	CT112436-001	11	D 119-10	117	J202527A	72
B 2424-210-000	35	CT118-45807	29	D 119-7	117	J204062	72
B2424-210-A00	35	CT118-45807	107	D 2402-555-BAB	35	J204072	72
B2514-860-G00	37	CT118-45807 G	29	D 2423-141-E00	39	J204161	72
B 2519-804-000	30	CT140567-001	11	D 2424-141-E00	39	J204702	72
B 2519-814-000	30	CT144077-001	11	D 250-17 B	117	J204949	72
B 2520-352-000	34	CT15320-3.0	64	D 250-18 A	117	J209685	72
B 2521-352-000	34	CT15320-3.5	64	D 250-39	117	J211.77	71
B 2521-804-000	30	CT15320-4.0	64	D4 USA	75	J211-0060	71
B 2523-180-000	41	CT15320-4.5	64	D5	75	J37L	49
B 2524-180-000	41	CT15320-5.0	64	D5 USA	75	J501BJ133	71
B 2701-180-F00 1/4	41	CT15320-6.0	64	D 60-3	117	J501GB107	71
B 2701-180-K00 3/8	41	CT164026	91	D 80-4	117	J501GB160	71
B 2701-180-L00 1/2	41	CT164308	91	D8 USA	75	JA815	49
B 2701-180-M00 5/8	41	CT164556	91	D9	75	JAB816A	49
B 2701-180-N00 3/4	41	CT167 L	110	D9 USA	75	JAB-A815	49
B 2701-180-P00 7/8	41	CT168 R	110	Diamant FR	128	JAB-A816	49
B 2701-180-Q00 1	41	CT169395x7.0	69	F0495H	134	JABD815	49
B 2701-180-R00 1 1/8	41	CT169395x9.0	69	F 23100-37 A	48	JABD816	49
B 2701-180-S00 1 1/4	41	CT200271-0-10	85	FR 40	97	JC37L	49
B 2701-180-T00 1 3/8	41	CT200274-0-10	85	FS 03	97	JC 816	49
B 2701-180-H00 9/16	41	CT200404-0-10	85	FS 04	97	JG37R	49
B 2702-047-A00 11/16	40	CT20491	121	FX0206000000	129	JGR1046-8	71
B 2702-047-F00 1/4	40	CT20491 G	121	FX0207000000 (CT)	129	JGR1049/2-8	71
B 2702-047-I00 7/16	40	CT210755	55	G 39508 A (UM)	104	JLB37R	49
B 2702-047-K00 3/8	40	CT235-06009	41	G 36240 (VD)	102	KB270010	127
B 2702-047-L00 1/2	40	CT3110038	124	G 36250 (CT)	102	KL 25	96
B 2702-047-M00 5/8	40	CT3543	116	G 39508 AV (GC)	104	KL 25 A	96
B 2702-047-N00 3/4	40	CT3544 A	116	G 39524 AV (GB)	105	KL 65	96
B 2702-047-P00 7/8	40	CT36270	102	G 39524 AW (GC)	105	KM 04	96
B 2702-047-Q00 1	40	CT37514	119	G 39549 JU	103	KN270950	127
B 2702-047-R00 1 1/8	40	CT37538	119	G 39549 N (CT)	103	KN270951	127



Teil-Nr. Part No.	Seite Page	Teil-Nr. Part No.	Seite Page	Teil-Nr. Part No.	Seite Page	Teil-Nr. Part No.	Seite Page
KN270952	127	P 127 Special	77	S34895-001	8	SE-R11-01A	131
KN270960	127	P12XN1	77	S34899-001	9	Setec	134
KN271602	127	P12XN1-SP	77	S35029-001	8	SH816-8	50
KN271980	127	P3-0146	128	S35033-001	8	SK816	50
KR 23	96	PL-Q11-01A	43	S35034-001	8	Sotco oben	128
KR-23A (CT)	96	PL-Q11-01A	131	S35092-001	9	Sotco unten	128
KR-23C (CT)	96	PL-Q11-01C	43	S35093-001	9	SSSS60-292	10
KR 35	96	PL-Q11-01C	131	S35410-001	8	SY0069084	4
KR-35C	96	PL-R11-01A	43	S35411-001	8	SY0069085	4
KR 55	96	PL-R11-01A	131	S35412-101	8	SY0069086	4
KZG 502 E	127	PN07338700	132	S35413-101	8	TL055	134
KZG 757	127	S00706-201	3	S35437-101	9	UL603880	47
LL603884	47	S00713-001	3	S35472-101	8	UL603880	95
LL603884	95	S01248-001	12	S35480-101	9	UL603881	47
LL604884	47	S01249-001	12	S37195-001	9	UL603881	95
LL604884	95	S02374-001	2	S37706-001	9	UL603886	47
LL604885	47	S02375-001	2	S37708-001	9	UL603886	95
LL604885	95	S02637-001	3	S37723-101	8	UL604883	47
LP 22	96	S02637-101	3	S37BL	50	UL604883	95
LP 24	96	S02645-001	3	S40375-001	5	UL605294	47
LP 26	96	S02646-001	3	S40375-001	10	UL605294	95
LP 36 A	96	S03536-001	5	S40376-001	5	VE 51	98
LS801158	134	S03627-001	5	S40376-001	10	VE 51 P	98
MAS-11012-000	37	S03629-001	5	S40377-001	5	VLA 48-4	99
MAS-11013-000	37	S07526-001	6	S40377-001	10	VLA 48-4	127
MAS-11016-000	37	S07526-201	6	S40389-001	10	Z10	134
MAS-11017-000	37	S07526-301	6	S40390-001	10	Z16	134
MAT 02203-000 (CT)	33	S07527-001	6	S40391-001	10	Z17	134
MAT 02204-000 (CT)	33	S080870223	27	S40392-001	10	Z21	134
MAT-03505000 (CT)	33	S080870238	27	S40393-001	10	Z29	134
MAT-03506000 (CT)	33	S080870239	27	S40394-001	10	Z41	134
MAT-0360500A (CT)	33	S08913-001	6	S425311018	27	Z42	134
MAT-03606000 (CT)	33	S08934-001	6	S425311018 HSS	27	Z43	134
ME 28	97	S09093-001 (CT)	6	S425311020	27	Z43	134
ME 28 P	97	S09094-001 (CT)	6	S425311020 HSS	27	ZA 815	48
Meca	128	S10205-001	2	S425311021	27	ZD 21	98
MF00A0834	52	S10210-001	2	S425311021 HSS	27	ZD 22	98
MF00A0838	52	S10210-201	2	S425311023	27		
MF02A0834	53	S10605-001	4	S425311024	27		
MF02A0838	53	S10605-201	4	S425870237	27		
MF16A0838	52	S12842-001	6	S44134-001	3		
MF40A1834	52	S12865-001	6	S45900-101	3		
MF40A1835	52	S16248-101	4	S49078-00	8		
MF40A2180	52	S20421-001	13	S49988-001	2		
MF40A2835	52	S20422-001	13	S50259-101	7		
MF90A0838	52	S20424-001	13	S50260-101	7		
MF90B0838	52	S20428-001	13	S50263-001	7		
MF90B2838	52	S20430-001	13	S50404-401	7		
MG40B0834	53	S20434-001	13	S55863-101	10		
MG40B0835	53	S20438-001	13	S55864-001	10		
MG44B0838	52	S20442-001	13	S70817001301	133		
MG52A0834	53	S20579-101	13	S70817001E02	133		
MG52A0838	53	S20582-001	13	S815-8	50		
MH 41	97	S20583-001	13	SA 6988-001	9		
MN50A0838	53	S20626-001	13	SA3330-001	2		
MP41A0838	53	S20653-001	13	SA3335-001	2		
MP41B0838	53	S20896-101	13	SA6431-001	2		
MS01A0838	52	S20897-101	13	SA6596-001	2		
MS01B0838	52	S20898-001	13	SA6989-001	9		
MS03A0838	53	S20899-001	13	SA7634-101	8		
MS03B0838	53	S 2-51 M	74	SA7944-101	2		
MS10A0838	53	S 2-51 N	74	SB1189-001	2		
MS3-017L	28	S 2-51 R	74	SB1191-001	2		
MS3-017R	28	S27634-001	4	SB4941-001	3		
MT 01	97	S31612-001	2	SB4942-101	3		
P 127	77	S32474-001	4	SE-R11-01A	43		



